

# **HAKKO** MODEL SOLDERING STATION **FM-202**

High-output, temperature controlled  
soldering station

## **Instruction Manual**



Thank you for purchasing the MODEL FM-202 soldering station. This high-output, temperature controlled soldering station uses a composite tip, incorporating heater and sensor functions into one element. Several process control features, unique to the MODEL FM-202, make it applicable to a broad range of soldering applications.

Please read this manual before operating the MODEL FM-202. Keep this manual readily accessible for reference.



### **TABLE OF CONTENTS**

1. PACKING LIST .....	1
2. SPECIFICATIONS .....	1
3. WARNINGS, CAUTIONS, NOTES AND EXAMPLES .....	2
4. PART NAMES .....	3
5. INITIAL SETUP .....	3
6. OPERATION .....	5
7. TIP IDENTIFICATION NUMBER .....	9
8. PARAMETER SETTINGS .....	10
9. MAINTENANCE .....	12
10. ERROR MESSAGES .....	14
11. TROUBLE SHOOTING GUIDE .....	15
12. PARTS LIST .....	17
13. TIP STYLES .....	20
14. APPENDIX A .....	22
15. WIRING DIAGRAM .....	23

# 1. PACKING LIST

MODEL FM-202 soldering station .....	1	Heat resistant pad .....	1
HAKKO FM-2027 connector assembly .....	1	Tip tray.....	1
Sleeve assembly .....	1	Iron holder .....	1
Power cord .....	1	Tip cleaner .....	1
Control card, with chain .....	1	Instruction manual .....	1
		Tips (not included)	

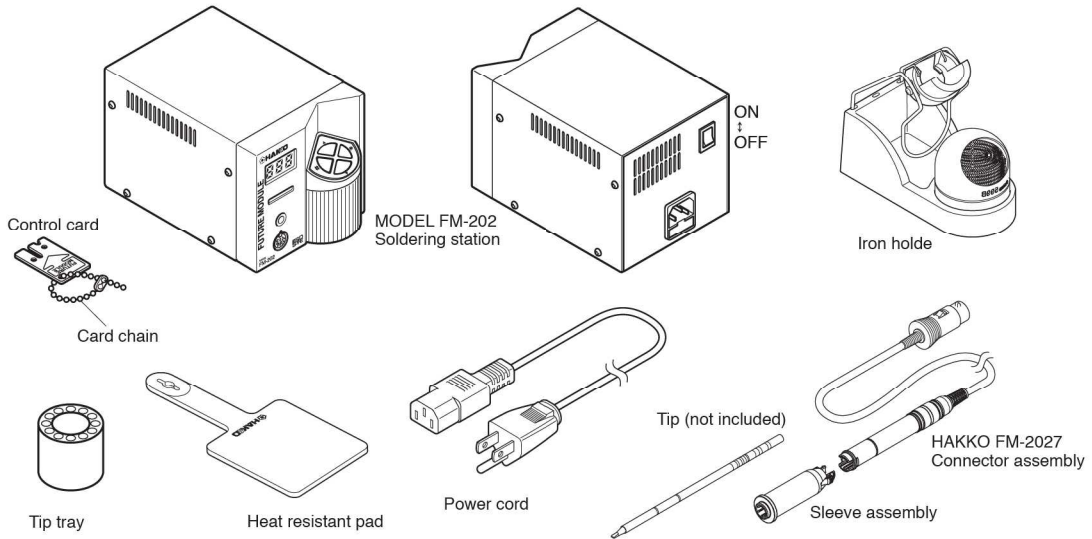

# 2. SPECIFICATIONS

## ● FM-202 soldering station

Power Consumption	140 W
Temperature Range	200 – 450°C (400 – 840°F)
Temperature Accuracy	±10°C (±18°F) of set temperature. See Figure 1.
Temperature Stability	±5°C (±9°F) at idle temperature

## ● Station

Output	24 V
Dimensions (W x H x D)	119 x 117 x 178 mm (4.7 x 4.6 x 7.0 in)
Weight	2.7 kg (5.9 lb.)

## ● Soldering iron

Power Consumption	70 W (24 V)
Tip to Ground Resistance	< 2 Ω
Tip to Ground Potential	< 2 mV
Total Length (w/o cord)	188 mm (7.4 in.) with 2.4D tip
Weight (w/o cord)	30 g (0.067 lb./1.07 oz.)with 2.4D tip
Cord	1.2 m (4 ft)

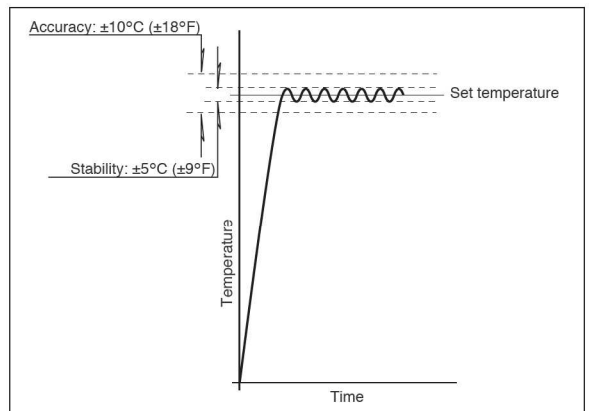

Figure 1. Temperature accuracy and stability.

### NOTE:

This product is protected against electrostatic discharge. This product meets China RoHS requirements. (See p. 23.) Specifications and design are subject to change without notice.

## ■ Electrostatic Protection

This product includes such features as electrically conductive plastic parts and grounding of the handpiece and station as measures to protect the device to be soldered from the effects of static electricity. Be sure to observe the following instructions:

1. The handle and other plastic parts are not insulators, they are conductors. When replacing parts or repairing, take sufficient care not to expose live electrical parts or damage insulation materials.
2. Be sure to ground the unit during use.

# 3. WARNINGS, CAUTIONS, NOTES AND EXAMPLES

Warnings, cautions and notes are placed at critical points in this manual to direct the operator's attention to significant items. They are defined as follows:

 **WARNING:** Failure to comply with a WARNING may result in serious injury or death.

 **CAUTION:** Failure to comply with a CAUTION may result in injury to the operator, or damage to the items involved. (Two examples are given below.)

**NOTE:** A NOTE indicates a procedure or point that is important to the process being described.

**EXAMPLE:** An EXAMPLE is given to demonstrate a particular procedure, point or process.

## CAUTION

When power is ON, tip temperatures will be between 200 and 450°C. To avoid injury or damage to personnel and items in the work area, observe the following:

- Do not insert any foreign substance or incompatible tip into the process gate.
- Do not insert the tip end of the cartridge into the process gate.
- Do not touch the tip or the metal parts near the tip.
- Do not allow the tip to come close to, or touch, flammable materials.
- Inform others in the area that the unit is hot and should not be touched.
- Turn the power off when not in use, or left unattended.
- Turn the power off when connecting the HAKKO FM-2027 or storing the FM-202.
- Do not remove or damage the bar code sticker.

## CAUTION

To prevent accidents or damage to the MODEL FM-202, be sure to observe the following:

- Do not use the MODEL FM-202 for applications other than soldering.
- Do not allow the MODEL FM-202 to become wet, or use it with wet hands.
- Do not modify the MODEL FM-202.
- Use only genuine Hakko replacement parts.
- Do not bend or damage the control card. If the card does become damaged, do not force the card into the station slot.
- Do not strike the iron against hard objects to remove excess solder. This will damage the iron.
- Remove power and iron cords by holding the plug – not the wires.
- Be sure the work area is well ventilated. Soldering produces smoke.

## 4. PART NAMES

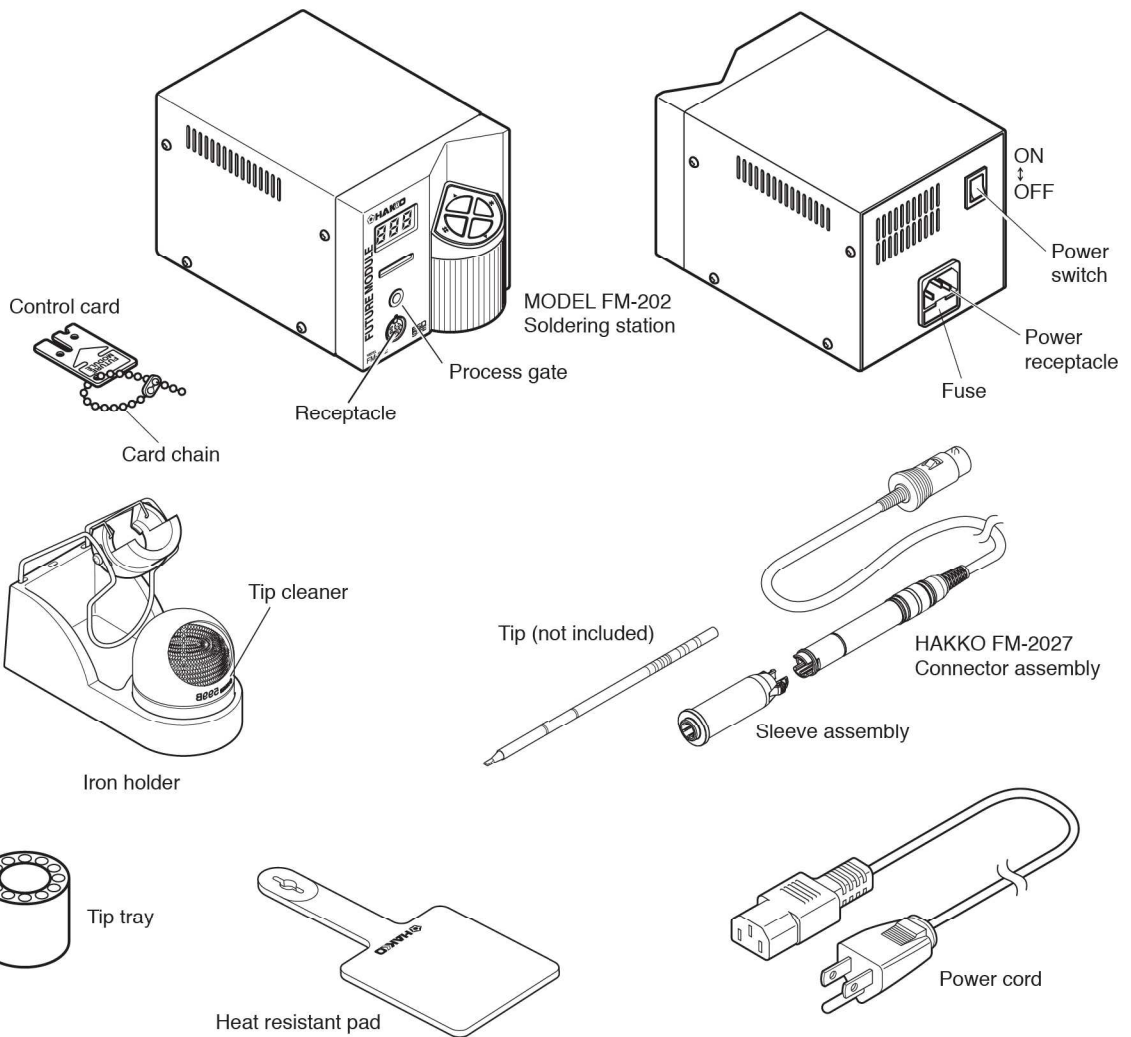

## 5. INITIAL SETUP

### A. Iron holder

1. Assemble as shown:
  - Insert the holder assembly securely into the Iron holder base.

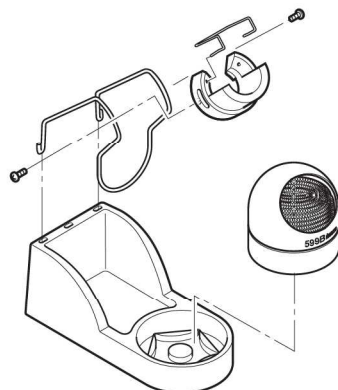



## 2. Operation:

First, remove any excess solder from the tip by thrusting the tip into the cleaning wire.

(Do not wipe the tip against the wire. This may cause molten solder to spatter.)

When the wire become dirty or loaded with solder, turn the wire until a clean surface is presented.

When changing the cleaning wire, lift the case top vertically to prevent solder debris from falling out.

## 3. Place the spare tips in the tip tray.

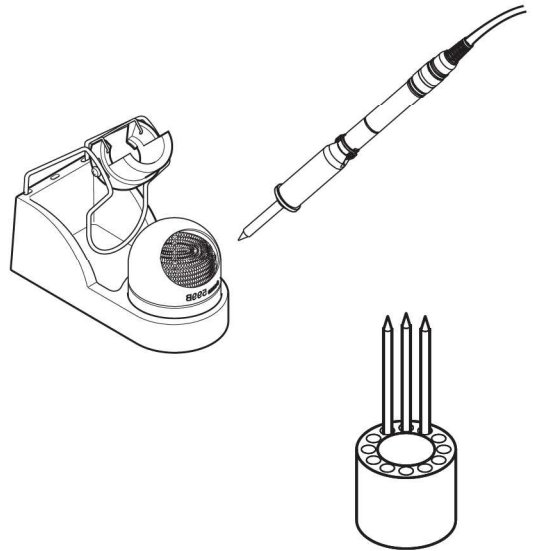

## B. Connector cord

Pass the connector cord through the hole in the heat resistant pad.

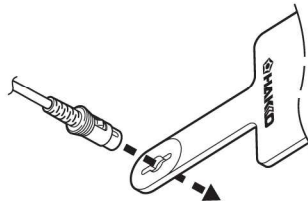

## C. Soldering station

1. Insert the power cord into the receptacle at the back of the station.

2. Insert the connector cord into the receptacle at the front of the station.

3. Plug the power cord into a grounded wall socket. The MODEL FM-202 is protected against electrostatic discharge and must be grounded for full efficiency.

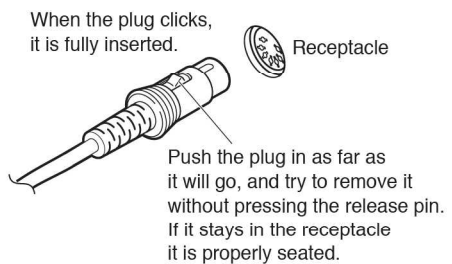

# 6. OPERATION

## Controls and displays

### Controls

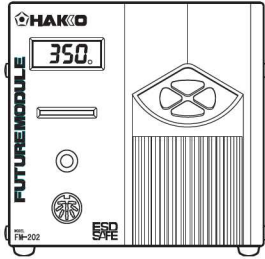

The front panel of the MODEL FM-202 soldering station has four control buttons, the process gate, the receptacle, and the card slot. The power switch is on the back panel.

- Four control buttons:

- **#** – Initiates the Tip ID entry mode. When pressed for less than one second, the stored Tip ID is displayed. When pressed for more than one second, the Tip ID entry mode is activated.
- **\*** – Initiates the temperature setting mode. When pressed for less than one second, the stored temperature is displayed. When pressed for more than one second, the temperature entry mode is activated.
- **▲** – Increases the value in the appropriate display window.
- **▼** – Decreases the value in the appropriate display window.

### Displays

The MODEL FM-202 has a three-digit display element. Depending upon the selected mode, it will display:

- Normal mode:  
Sensor temperature (tip temperature)
- Data entry:  
Selected quantity (see “data entry procedures” for exact characteristics)
- Temperature scale:  
°C or °F, depending upon selection
- Error detection:  
Refer to “ERROR MESSAGES” section

In addition, a single heater lamp will flash when the station has reached the desired temperature, indicating that it is ready for use.

An audible buzzer is provided to alert the operator:

- When the station has reached the set temperature. The buzzer will sound once.
- When the tip is inserted into the process gate, the buzzer will sound once when the Tip ID bar code has been read.
- When the low temperature threshold has been crossed, the buzzer will sound continuously. The buzzer will shut off once the sensed temperature returns to the acceptable range.
- When a foreign substance, an incompatible tip, or the soldering end of the tip is inserted into the HAKKO FM-2027, the display will flash and the buzzer will sound continuously.
- When the auto power shutoff is activated and power to the heating element is turned off, the buzzer will sound three times.
- When the process gate cannot read the Tip ID bar code, the buzzer will sound three times.
- When a tip is inserted into the process gate while the tip is already in the HAKKO FM-2027, buzzer will sound irregularly.
- When the tip is properly inserted into the connector, the buzzer will sound once.

When a tip ID has not been entered, or when a tip is NOT inserted into the HAKKO FM-2027, the following procedure obtains:

1. Turn the power switch ON.
2. The display will show **00** (Tip ID number) and the LED on the connector will flash. The display will show the set temperature and **E-E**.
3. Enter tip ID as follows:  
Insert the tip ID end of the tip into the process gate until the buzzer sounds ONCE. Tip ID data are displayed for one second. The display then shows **S-E**. The LED indicator will stop flashing, indicating that the data are now stored. Once the tip is inserted into the connector, heat control begins.
4. When the set temperature is reached, the buzzer sounds and the heater lamp at the lower right of the temperature display starts blinking.

When a tip ID has been entered, or when a tip is inserted into the HAKKO FM-2027, the following procedure obtains:

1. Turn the switch ON.
2. The display will show the initial temperature setting.
3. Heat control begins.

## ● Factory settings

The MODEL FM-202 comes from the factory with the following values preset:

Temperature scale	<b>1 0</b>	Celsius
Auto power shutoff	<b>2 0</b>	disabled
Low temperature alarm setting	<b>150</b>	150°C
Resetting the supervisor or operator control setting	<b>4 0</b>	disabled
Set temperature	<b>350</b>	350°C

\*The MODEL FM-202 is preset at Tip ID mode at the factory.

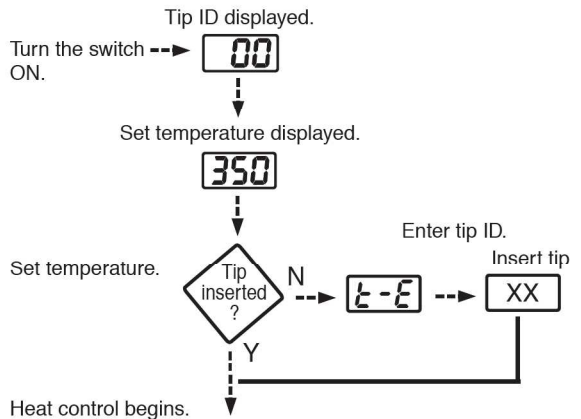

**NOTE:**  
The MODEL FM-202 is preset at 350°C. at the factory. Check the temperature setting by pressing the **★** button. The set temperature will be displayed for two seconds.

**NOTE:**  
If the buzzer sounds three times when the tip is inserted into the process gate, there has been a reading error. Reinsert the tip.

**CAUTION:**  
Refrain from inserting foreign objects, the wrong end of the tip, or incompatible tips into the process gate. Damage may result.

## ● Control card

## ● Changing the temperature setting

Example: 350 to 400°C

### 1. Insert the control card into the slot in the front of the unit.

- The *hundreds* digit will begin to flash, indicating that the unit is in the TEMPERATURE SET mode and data may be entered.

### 2. Entering the *hundreds* digit

- Press the ▲ or ▼ button to set the desired value. **Only 2, 3, or 4 can be selected.**

When the desired value is displayed, press the \* button to enter. The *tens* digit will begin to flash.

### 3. Entering the *tens* digit

- Press the ▲ or ▼ button to set the desired value. **Any value from 0 to 9 can be selected.** When the desired value is displayed, press the \* button to enter. The *units* digit will begin to flash.

### 4. Entering the *units* digit

- Press the ▲ or ▼ button to set the desired value. When the desired value is displayed, press the \* button to enter. The desired temperature is now entered into the system memory and heater control will begin.

#### NOTE:

If power is switched off or lost during the execution of this procedure, no data will be entered. The entire procedure must be repeated from step 1.

Each MODEL FM-202 comes with a small card, which inserts into the Card slot on the front of the unit. This card is used when entering data for the process control function (a temperature value is to be changed, or data are to be entered). Any MODEL FM-202 card can be used with any MODEL FM-202 soldering station.

#### ⚠ CAUTION:

The control card must be inserted into the card slot in the correct direction for data to be entered.

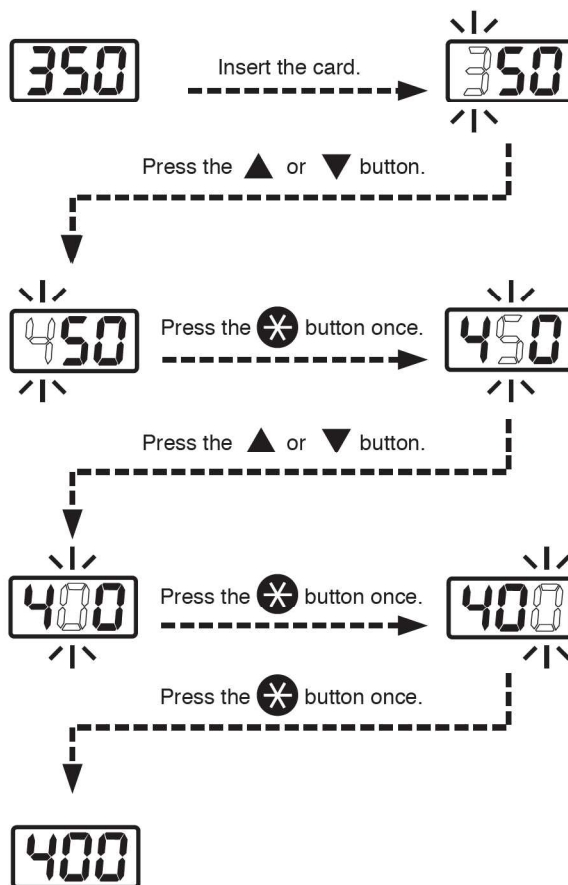

**When the station is ON and the control card is in the station, the data entry procedure is:**

- Hold the  button down for at least one second.
- The current temperature setting will be displayed, then the *hundreds* digit will begin to flash. This indicates that the station has entered the temperature setting mode.
- Follow steps 1-4 on the preceding page.

**NOTE:**

When the  button is pressed for less than one second, the current temperature setting is displayed.

● **Replacing the tip**

 **CAUTION:**

The tip may be hot. Avoid holding the hot tip for a long time even if using the heat-resistant pad. Otherwise burns may result.

**Removing the tip:**

- Holding down the lock release buttons in the sleeve assembly, pull out the tip together with the sleeve assembly from the connector.

 **CAUTION:**

- Be sure to keep the lock release buttons held down while pulling out the sleeve assembly. Failure to do so will damage the locking mechanism.
- Be sure to pull out the tip only after separating the sleeve assembly from the connector. Otherwise, the sleeve assembly may fall down and break.

- Holding the front end of the sleeve assembly, pull out the tip.

**Inserting the tip:**

- Holding the front end of the tip, insert it into the sleeve assembly.

 **CAUTION:**

Insert the tip into the sleeve assembly until it clicks into place. When you hear it clicks, avoid forcing the tip into the sleeve assembly.

- Insert the "ID" end of the tip into the process gate until the buzzer sounds so that the tip ID can be read out.
- Insert the tip securely into the connector.

**NOTE:**

Improper insertion of the tip will cause  to appear on the display.

Remove the tip from the connector while pressing these parts.

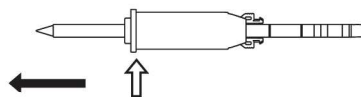
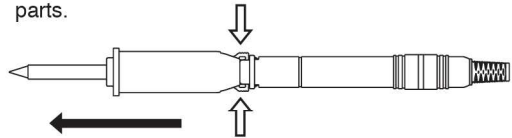

Hold the front part of the sleeve assembly to remove the tip.

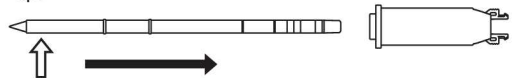

Hold this part to insert the tip into the sleeve assembly.

 **CAUTION:**

When holding the head of the tip, there is a danger of burn. Be sure to use the heat-resistant pad.

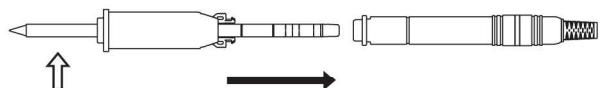

Hold this part to insert the tip into the connector.



# 7. TIP IDENTIFICATION (TIP ID) NUMBER

## ● Entering the Tip ID number

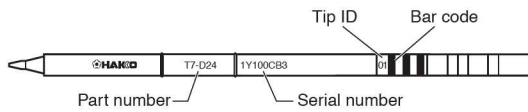

### ⚠ CAUTION:

Do not damage or remove the bar code sticker of the Tip ID number.

### How to read out the bar code of the tip into the MODEL FM-202:

1. Insert the tip (connector side) into the process gate in the front of the station.
2. Insert the tip until the buzzer sound once. The display shows **S-E**. The LED indicator will stop flashing. Now the tip identification number has been stored.

Soldering tips have different thermal characteristics, depending upon their mass, shape, and surface area. It should be obvious that the tip temperature at idle will not be the same for a fine tip as it will be for a heavy chisel tip, although the set temperature may be the same for each tip. The MODEL FM-202 processor incorporates the ability to electronically compensate for tip geometry variations using Tip IDs. Each MODEL FM-202 tip shape has a specific Tip ID; whenever a tip is changed, the Tip ID should be entered into the MODEL FM-202 for most effective process control.

There are two ways to enter Tip ID data into the MODEL FM-202:

See below or page 6 of this manual. This procedure is the simplest and most common.

See Appendix A of this manual, when the Tip ID is not readable for some reason.

### NOTE:

When the buzzer sounds three times is reading error, insert the tip again.

### ⚠ CAUTION:

Do not insert the tip opposite side or other incompatible tip.

### ⚠ CAUTION:

When tip is inserting the HAKKO FM-2027, the process gate cannot read the bar code. If a tip insert into the process gate while the tip is already in the HAKKO FM-2027, buzzer will sound irregularity. Remove the tip from the HAKKO FM-2027 for reading the Tip ID.

# 8. PARAMETER SETTINGS

## ● Entering the parameters

### (1) °C or °F temperature display

### (2) Auto power shutoff



This is an optional setting. When it is activated and the soldering iron is not used for 30 minutes, the power to the heating element is shutoff automatically and the buzzer will sound three times. When the temperature decreases to 100°C/200°F the display will show ---. To resume soldering, cycle the power switch OFF, then ON. The power will be turned on automatically if you hit any button before the temperature decreases to 100°C/200°F.

To bypass this procedure and continue to resetting the low temperature alarm tolerance setting press the  button once.



The MODEL FM-202 has the following four parameters:

- 1) °C or °F temperature display selection
- 2) Auto power shutoff
- 3) Low-temperature alarm tolerance setting
- 4) Supervisor or operator control setting



Once the station enters parameter mode, set the parameters in the order shown below. Once all the parameters have been set, normal operation will be resumed.

1. Turn power OFF.
2. Insert the control card into the card slot in the front of the unit.
3. Press and hold down the  button, and then turn power ON.
4. The display will show the Tip ID for one second. Hold the  or  button down until the display shows 1 C (Celsius) or 1 F (Fahrenheit).

When either of these are displayed, the station is in parameter input mode.

- Pressing either the  or  button will cause the display to alternate between 1 C or 1 F.
- When the desired scale is displayed, select by pressing the  button. The system will automatically sequence to auto power shutoff mode.

To change the auto power shutoff setting, the procedure is as follows.

- The display will show 2 1 or 2 0 when this mode is entered.
- Using  or  button will change 2 1 and 2 0.  
The autopower shutoff is operational only when 2 1 is selected.
- Press the  button to enter the parameter. This will store the setting in system memory and the system will automatically sequence to the low temperature alarm tolerance setting mode.

### (3) Resetting the low temperature alarm tolerance setting

This unique function alerts the operator when the sensed temperature drops below a set limit. Should this occur, an error message **H-E** will be displayed, and the buzzer will sound continuously. When the temperature returns within the allowable range, the buzzer will stop. The value is stored in the MODEL FM-202 as described below:

**EXAMPLE:**

If the set temperature is 350°C and the low temperature alarm is 50°C, the alarm will trip when the sensed temperature goes below 300°C.

**NOTE:**

The threshold limits are: 30 – 150°C; 60 – 300°F. If a value outside these limits should be entered, the system will revert to the beginning of the mode, the hundreds digit will flash, and the procedure must be restarted.

To bypass this procedure, press the **✖** button three times.

Range of allowable low-temperature alarm tolerance

For °C: 30 – 150°C

For °F: 60 – 300°F

### (4) Supervisor or operator control setting

This mode allows control over the Tip ID data entry to be assigned to a card-holder.

**NOTE:**

Whether the card is inserted or not, process gate works.

1. When the station enters low-temperature alarm tolerance setting mode, the hundreds digit begun flashing. Enter and store the value in the same manner as described on page 7 “Changing the temperature setting.”
2. If you enter a value exceeding the allowable range shown to the left, you will be brought back to entering a value in the hundreds digit. If this occurs, reenter a correct value.
3. Once the value is stored, the system will automatically sequence to the resetting the supervisor or operator control setting.

To change the control selection, proceed as follows:

1. When the mode is entered, the display will show **4 0** or **4 1**  
**4 0**: Tip ID cannot be entered without inserting the control card.  
**4 1**: Tip ID can be entered without inserting the control card.
2. Pressing either the **▲** or **▼** button will cause the display to alternate between **4 1** and **4 0**.
3. When the desired setting is displayed, select by pressing **✖** button. The system will exit the parameter setting mode and begin heater control. It is now ready for normal operation.

# 9. MAINTENANCE

---

## ● Tip maintenance

### 1. Tip temperature

High temperatures shorten tip life and may cause thermal shock to components. Always use the lowest possible temperature when soldering. The excellent thermal recovery characteristics of the MODEL FM-202 ensure effective soldering at low temperatures.

### 2. Cleaning

Always clean the soldering tip before use, to remove any residual solder or flux adhering to it. Use the 599B tip cleaner (provided with the MODEL FM-202) or use a clean and moist cleaning sponge (part no.A1519). Contaminants on the tip have many deleterious effects, including reduced heat conductivity, which contribute to poor soldering performance.

### 3. After use

Always clean the tip and coat it with fresh solder after use. This guards against oxidation.

### 4. When the unit is not being used and the auto power shutoff is not active.

Never allow the unit to idle at a high temperature for extended periods. This will allow the tip to become oxidized. Turn the power switch OFF. If it is to be out of service for several hours, it is advisable to pull the power plug as well.

### 5. Inspecting and cleaning the tip

This procedure, if followed daily, will materially add to tip life.

- a. Set the temperature to 250°C (482°F).
- b. When the temperature stabilizes, clean the tip (see 2, above) and check the condition of the tip. If the tip is badly worn or deformed, replace it.
- c. If the solder plated part of the tip is covered with black oxide, apply fresh solder, containing flux, and clean the tip again. Repeat until all the oxide is removed, then coat the tip with fresh solder.

<p><b>⚠ CAUTION:</b> NEVER file the tip to remove oxides!</p>
---

- d. Turn the power OFF and remove the tip, using the heat resistant pad. Set the tip aside to cool.
- e. Remaining oxides, such as the yellow discoloration on the tip shaft, can be removed with isopropyl alcohol.



## ● Checking Procedure

### ⚠ WARNING:

Unless otherwise directed, carry out these procedures with the power switch OFF and the power UNPLUGGED.

### ■ Check for a broken heater or sensor

1. Check for a broken heater or sensor

Measure the resistance across this position.



Verify the electrical integrity of the heater and sensor.

Measure the resistance of the heater and sensor while at room temperature (15 to 25°C; 59 to 77°F). It should be  $8\Omega \pm 10\%$ . If the resistance exceeds these limits, replace the tip.

### ■ Check the grounding line

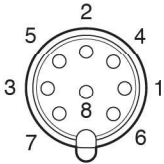

### ■ Checking the connection cord for breakage

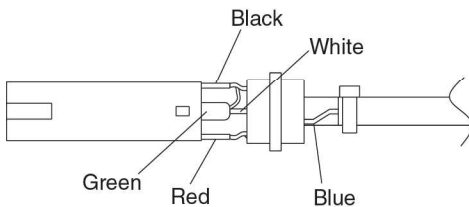

1. Unplug the connection cord from the station.
2. Measure the resistance value between Pin 2 and the tip.
3. If the value exceeds  $2\Omega$  (at room temperature), perform the tip maintenance described on p.12. If the value still does not decrease, check the connection cord for breakage.

1. Remove the soldering tip and the sleeve assembly.
2. Turn the front piece of the HAKKO FM-2027 clockwise and remove the cover.
3. Measure the resistance values between the connector and the lead wires at the socket as follows:

Pin 1 – Red      Pin 2 – Green

Pin 3 – Black    Pin 5 – White

If any value exceeds  $0\Omega$  or is  $\infty$ , replace the HAKKO FM-2027.

### ■ Replacing the fuse

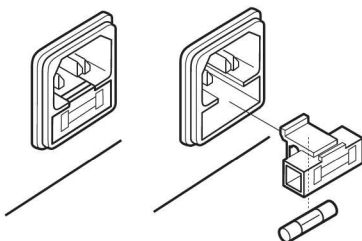

1. Unplug the power cord from the power receptacle.
2. Remove the fuse holder.
3. Replace the fuse.
4. Put the fuse holder back in place.



# 10. ERROR MESSAGES

## ● Sensor Error



## ● Low-temperature alarm tolerance error



### EXAMPLE:

350°C (400°C – 50°C)  
Set temperature — Low-temperature alarm tolerance

OR

650°F (750°F – 100°F)  
Set temperature — Low-temperature alarm tolerance

## ● Heater terminal short circuit error



## ● Tip ID error

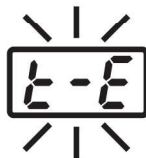

## ● Soldering iron error



When there is the possibility that a failure has occurred in the sensor or heater (including the sensor circuit), **S-E** is displayed and the power is shut down.

### NOTE:

The sensor error also occurs if the tip is not inserted properly.

If the sensor temperature falls below the difference between the current temperature setting and the low-temperature alarm tolerance, **H-E** is displayed and the warning buzzer sounds. When the tip temperature rises to a value within the set tolerance, the buzzer will stop sounding.

### EXAMPLE:

Assume that the temperature setting is 400°C/750°F and the tolerance 50°C/100°F. If the temperature continues to decrease and finally falls below the value indicated below while the heating element is on, the displayed value starts blinking to indicate that the tip temperature has dropped.

**HSE** will flash, and the buzzer will sound continuously, when the tip is inserted wrong way round, an incompatible tip is inserted, or a foreign object has found its way into the connector.

**T-E** will flash, and the buzzer will sound three times, if the process gate cannot read the Tip ID.

**I-E** will be displayed if Tip ID has not been entered.

**I-E** will be displayed if the connector cord is not attached to the station OR the wrong soldering iron is connected.

# 11. TROUBLE SHOOTING GUIDE

## WARNING:

- Before checking the inside of the MODEL FM-202 or replacing parts, be sure to disconnect the power plug. Failure to do so may result in electric shock.

- The unit does not operate when the power switch is turned on.

**CHECK** : Is the power cord and/or the connection plug disconnected?

**ACTION** : Connect it.

**CHECK** : Is the fuse blown?

**ACTION** : Investigate why the fuse blew and then replace the fuse. If the cause can not be determined, replace the fuse. If the fuse blows again, send the unit in for repair.

- The tip does not heat up.

- The sensor error **S-E** is displayed.

**CHECK** : Is the tip inserted properly?

**ACTION** : Insert the tip completely.

**CHECK** : Is the connection cord and/or the heater/sensor broken?

**ACTION** : See the appropriate section of this manual regarding how to check the connection cord and/or the heater/sensor for breakage.

- Solder does not wet the tip.

**CHECK** : Is the tip temperature too high?

**ACTION** : Set the appropriate temperature.

**CHECK** : Is the tip contaminated with oxide?

**ACTION** : Remove the oxide (see "Tip maintenance" on P. 12).

- The tip temperature is too high.

**CHECK** : Is the connection cord broken?

**ACTION** : See "Checking the connection cord for breakage" on P. 13.

**CHECK** : Is the entered tip identification number correct?

**ACTION** : Enter the correct value.

- The tip temperature is too low.

**CHECK** : Is the tip contaminated with oxide?

**ACTION** : Remove the oxide (see "Tip maintenance" on P. 12).

**CHECK** : Is the entered tip identification number correct?

**ACTION** : Enter the correct value.

- The soldering iron error **L-E** is displayed.

**CHECK** : Is the other soldering iron connected? Or the HAKKO FM-2027 plug disconnected?

**ACTION** : Connect the HAKKO FM-2027 soldering iron.

- The low-temperature alarm tolerance error **H-E** occurs frequently.

- Tip ID error **L-E** is displayed.

- Heater terminal short circuit error **HSE** is displayed.

**CHECK** : Is the tip too small for the items to be soldered?

**ACTION** : Use a tip with a larger thermal capacity.

**CHECK** : Is the setting value for the low-temperature alarm tolerance too low?

**ACTION** : Increase the setting value.

**CHECK** : Is the procedure of the entering tip identification number correct?

**ACTION** : Entering correctly.

**NOTE:**

If reinsert the tip into the process gate and buzzer sounding three times. Try to insert again or entering the Tip ID by hand operation.

**CHECK** : Is the tip for HAKKO FM-2027?

**ACTION** : Turn the power switch OFF and insert the genuine HAKKO FM-2027 tip. Turn the power switch ON.

**NOTE:**

This error does not display when not entering the Tip ID.

# 12. PARTS LIST

**NOTE:**

Spare or repair parts do not include mounting screws, if they are not listed on the description. Screws must be ordered separately.

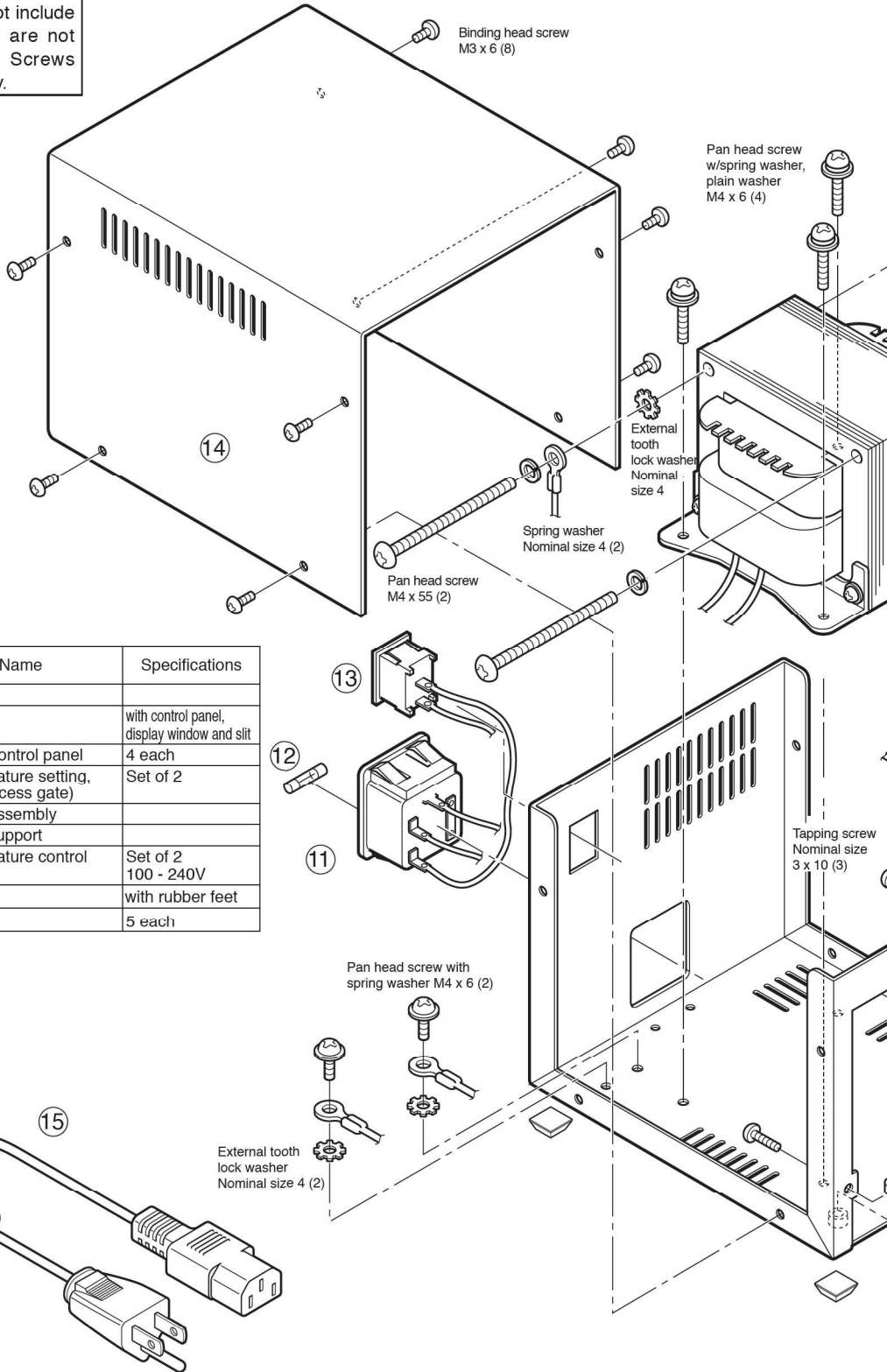

● **FM-202 Station**

Item No.	Part No.	Part Name	Specifications
①	B2749	Control card	
②	B2741	Front panel	with control panel, display window and slit
③	B2742	Button set for control panel	4 each
④	B2869	P.W.B. (temperature setting, display and process gate)	Set of 2
⑤,⑥	B2870	Process gate assembly	
⑥	B2871	Process gate support	
⑦	B2915	P.W.B. (temperature control and connector)	Set of 2 100 - 240V
⑧	B2740	Chassis	with rubber feet
⑨	B2757	Locking spacer	5 each

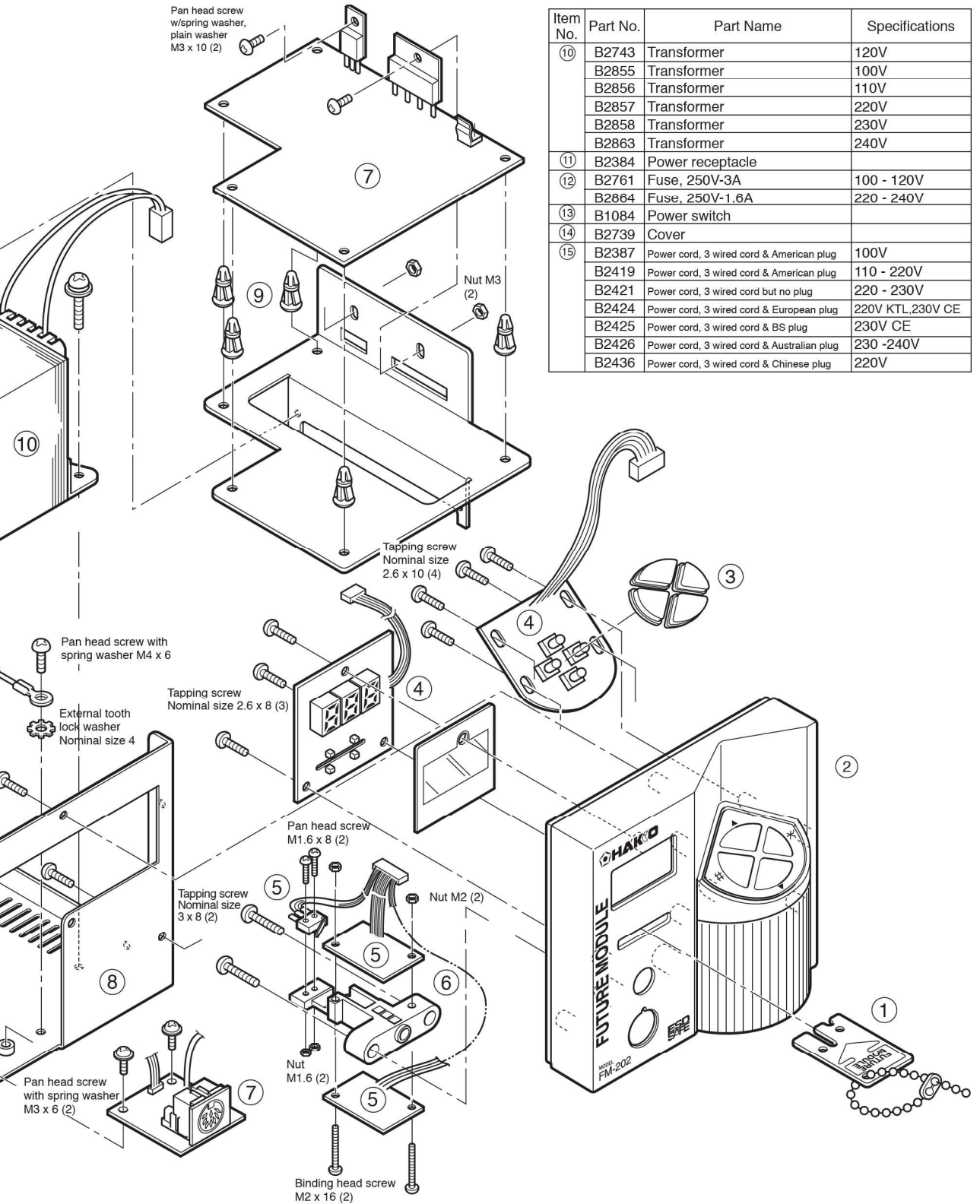

Item No.	Part No.	Part Name	Specifications
⑩	B2743	Transformer	120V
	B2855	Transformer	100V
	B2856	Transformer	110V
	B2857	Transformer	220V
	B2858	Transformer	230V
	B2863	Transformer	240V
⑪	B2384	Power receptacle	
⑫	B2761	Fuse, 250V-3A	100 - 120V
	B2864	Fuse, 250V-1.6A	220 - 240V
⑬	B1084	Power switch	
⑭	B2739	Cover	
⑮	B2387	Power cord, 3 wired cord & American plug	100V
	B2419	Power cord, 3 wired cord & American plug	110 - 220V
	B2421	Power cord, 3 wired cord but no plug	220 - 230V
	B2424	Power cord, 3 wired cord & European plug	220V KTL, 230V CE
	B2425	Power cord, 3 wired cord & BS plug	230V CE
	B2426	Power cord, 3 wired cord & Australian plug	230 - 240V
	B2436	Power cord, 3 wired cord & Chinese plug	220V



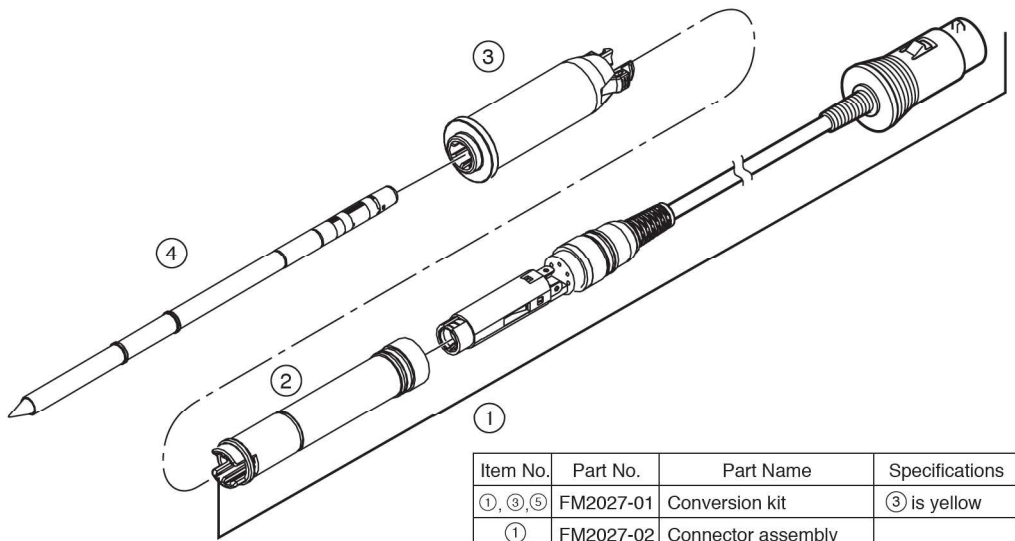

Item No.	Part No.	Part Name	Specifications
①, ③, ⑤	FM2027-01	Conversion kit	③ is yellow
①	FM2027-02	Connector assembly	
②	B3215	Connector cover	
③	B3216	Sleeve assembly	Yellow
	B3217	Sleeve assembly	Orange
	B3218	Sleeve assembly	Blue
	B3219	Sleeve assembly	Green
④		Tip	See section '13. TIP STYLES'
⑤	B2300	Heat resistant pad	

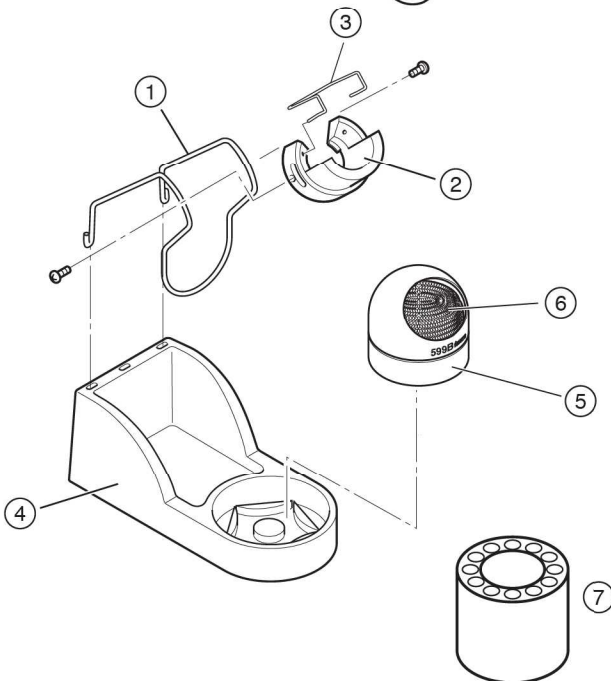
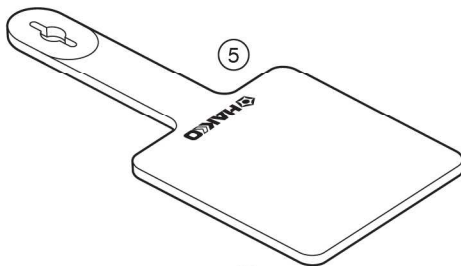

### • Iron Holder

Item No.	Part No.	Part Name	Specifications
① ~ ⑥	FH100-01	Iron holder	

### • Iron Holder Parts

Item No.	Part No.	Part Name	Specifications
①	B3000	Holder for iron receptacle	
②	B3001	Iron receptacle	Yellow/with screw
③	B2791	Retaining clip	
④	B2999	Iron holder base	Blue/with rubber feet
⑤	599B-02	Tip cleaner	
⑥	599-029	Cleaning wire	
⑦	B2756	Tip tray	

# 13. TIP STYLES

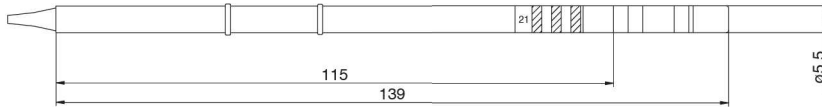

Unit:mm

T7-B SHAPE-B Conical

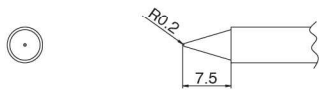

T7-B2 SHAPE-0.5B Conical

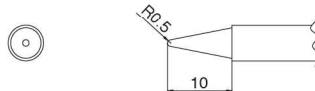

T7-BC1 SHAPE-1BC Bevel

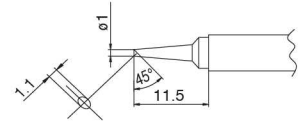

T7-BCF1 SHAPE-1BC Bevel  
(Tinned on the soldering surface only)

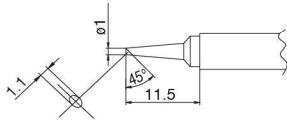

T7-BC2 SHAPE-2BC Bevel

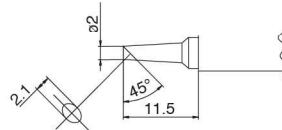

T7-BCF2 SHAPE-2BC Bevel  
(Tinned on the soldering surface only)

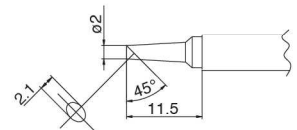

T7-BC3 SHAPE-3BC Bevel

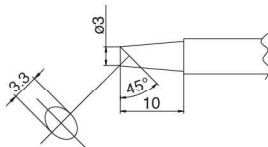

T7-BCF3 SHAPE-3BC Bevel  
(Tinned on the soldering surface only)

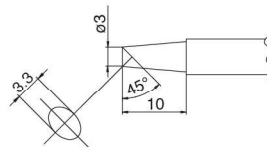

T7-C1 SHAPE-1C Bevel

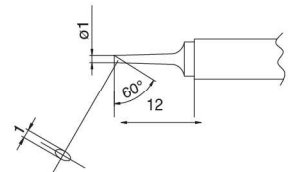

T7-C4 SHAPE-4C Bevel

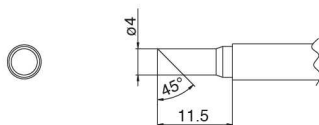

T7-CF4 SHAPE-4C Bevel  
(Tinned on the soldering surface only)

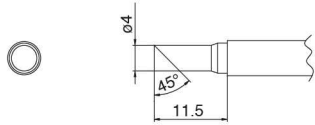

T7-D08 SHAPE-0.8D Chisel

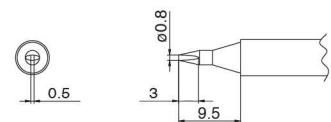

T7-D12 SHAPE-1.2D Chisel

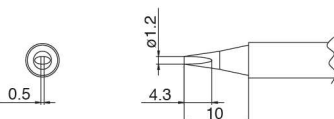

T7-D16 SHAPE-1.6D Chisel

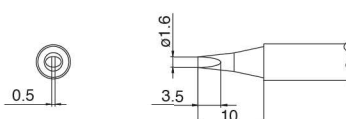

T7-D24 SHAPE-2.4D Chisel

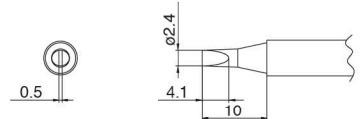

T7-D32 SHAPE-3.2D Chisel

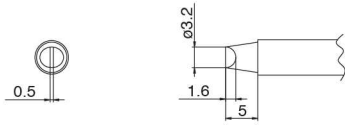

T7-D4 SHAPE-4D Chisel

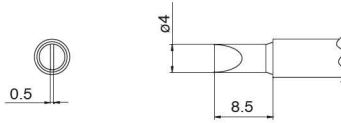

T7-D52 SHAPE-5.2D Chisel

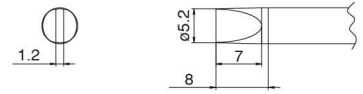

T7-I SHAPE-I Sharp Conical

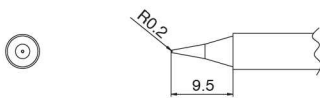

T7-J02 SHAPE-0.2RSB Bent

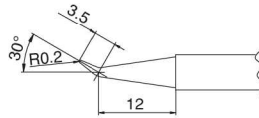

T7-JL02 SHAPE-0.2RLB Bent

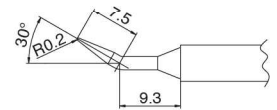

T7-JS02 SHAPE-0.2RSSB Bent

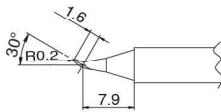

T7-K SHAPE-K Knife

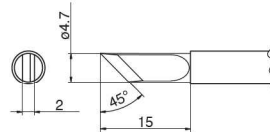

T7-KF SHAPE-KF Knife

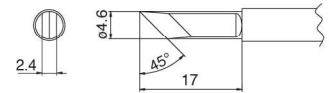

T7-KL SHAPE-KL Knife

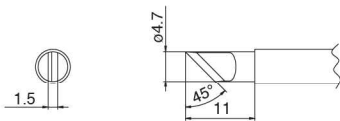

T7-KU SHAPE-KU Knife

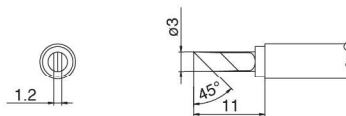

T7-LB SHAPE-LB Long Conical

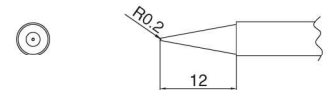

T7-LI

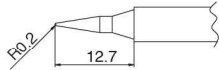

T7-1401



T7-1404

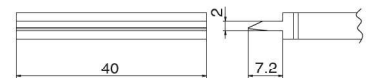
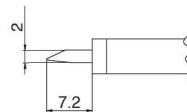

# 14. APPENDIX A

How to enter the tip identification number into the MODEL FM-202:

## 1. Insert the card to unlock the system.

## 2. Press the # button and hold for more than one second.

- The station will go into Tip ID mode. The *tens* place digit begins to flash. Refer to the tip identification number marked on the bar code sticker.

**NOTE:**

When the # button is pressed for less than one second, the stored Tip ID number settings are displayed.

## 3. Entering a value in the *tens* place digit

- Using the ▲ or ▼ button, enter a value in the *tens* place digit. When the entered value is displayed, press the \* button. The *units* digit begins to flash.

## 4. Entering a number in the *units* digit

- Perform the same steps used to enter the value in the *tens* place digit. After entering a number in the *units* digit, press the \* button. The display shows [S-E] will be flashing. Now the Tip ID number has been stored. The temperature will be controlled using this Tip ID number.

### Example:

When the tip identification number is 07.

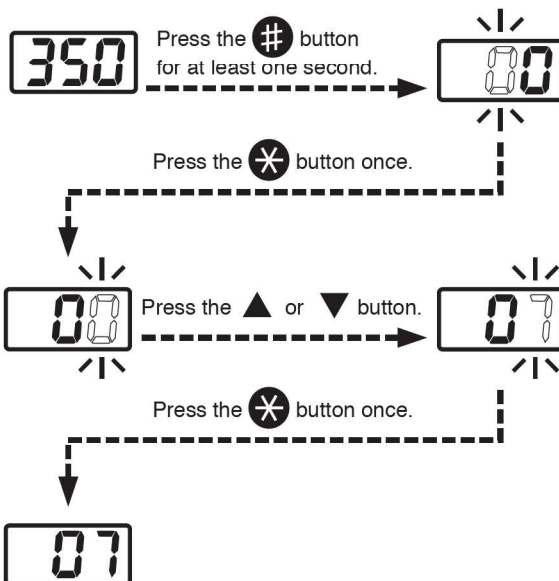

**NOTE:**

When tip is inserting the HAKKO FM-2027 and changing the Tip ID, no display [S-E] but display the setting temperature.

# 15. WIRING DIAGRAM

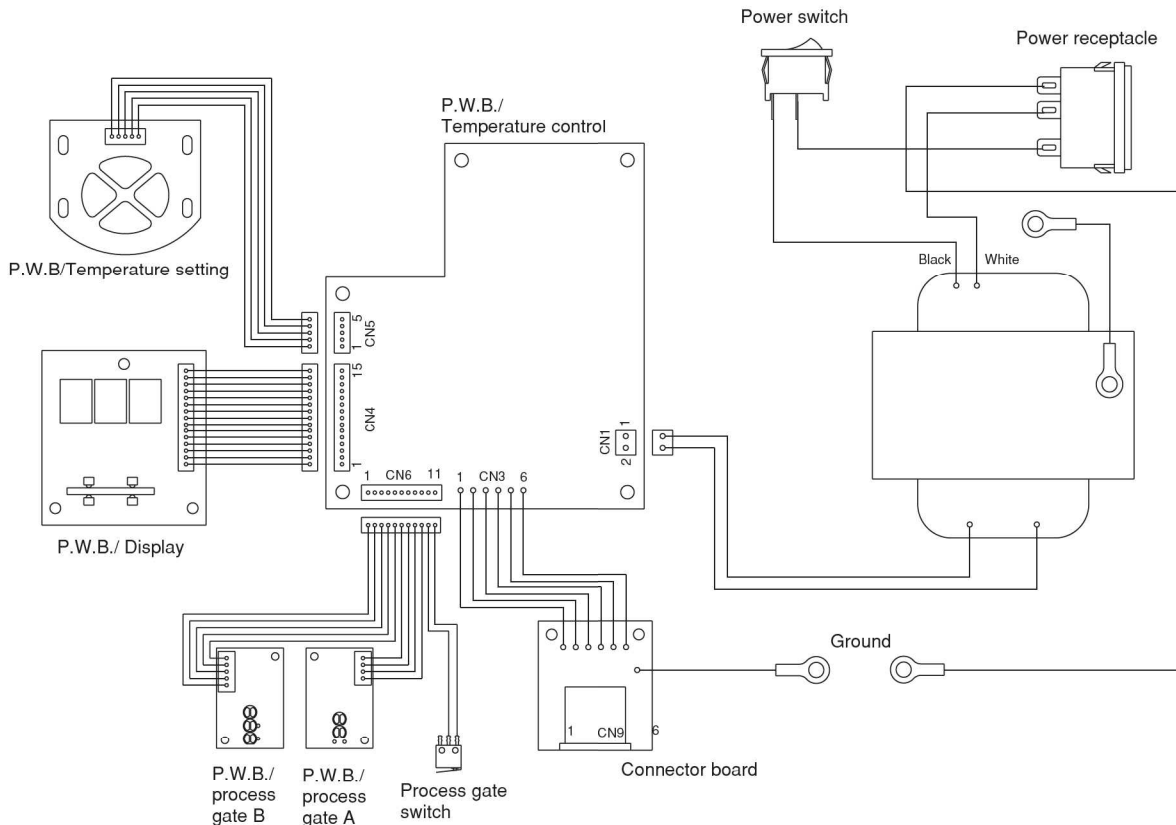

## 中國RoHS: 產品中有毒有害物質或元素的名稱及含量

部件名稱	有毒有害物質或元素					
	鉛(Pb)	汞(Hg)	鎳(Cd)	六價鉻(Cr(VI))	多溴聯苯(PBB)	多溴二苯醚(PBDE)
焊鐵部	×	○	○	○	○	○
插頭	×	○	○	○	○	○

○ : 表示該有毒有害物質在該部件所有均質材料中的含量均在SJ/T 11363-2006標準規定的限量要求以下。  
 × : 表示該有毒有害物質至少在該部件的某一均質材料中的含量超出SJ/T 11363-2006標準規定的限量要求。

注有「附帶 BS 插頭」之時，表示「插頭」為含有有害物質的部件。



### HAKKO CORPORATION

#### HEAD OFFICE

TEL:+81-6-6561-3225 FAX:+81-6-6561-8466  
<http://www.hakko.com> E-mail:sales@hakko.com

#### OVERSEAS AFFILIATES

U.S.A.: AMERICAN HAKKO PRODUCTS, INC.

TEL: (661) 294-0090 FAX: (661) 294-0096

Toll Free (800)88-HAKKO

<http://www.hakkousa.com>

HONG KONG: HAKKO DEVELOPMENT CO., LTD.

TEL: 2811-5588 FAX: 2590-0217

<http://www.hakko.com.hk>

E-mail:info@hakko.com.hk

SINGAPORE: HAKKO PRODUCTS PTE., LTD.

TEL: 6748-2277 FAX: 6744-0033

<http://www.hakko.com.sg>

E-mail:sales@hakko.com.sg

Please access to the following address for the other Sales affiliates.

<http://www.hakko.com>