



PAGE[®]

PRC 2000 SYSTEMS

SYSTEM OPERATION

& MAINTENANCE

MANUAL





MANUAL NO. 5050-0313

REV. H



TABLE OF CONTENTS

TITLE	PAGE
General Information	7
Use Of This Manual	7
Introduction	7
Specifications	8
Capabilities	10
Primary Controls	11
Pulse Heat	12
Pulse Plate	13
MicroChine	14
Pik And Paste	15
Thermal Management Center	16
Parts Identification	18
System	18
Front Panel Features	19
Rear Panel	27
Safety	29
Set-Up	31
System	31
Handpiece Vacuum/Pressure	33
Procedures	33
Operation	37
Introduction	37
Definitions	37
Thermal Management Center	38
Power Up	39
Operation	39
Factory Settings	39
Tip & Temperature Selection	50
Password	51
Calibration	62
Temperature Limits	66
Temperature Setback	68
Automatic Power Down	72
Digital Readout Message Codes	73
Quick Reference - System Operation	75
Foot Pedal	78



TABLE OF CONTENTS

TITLE	PAGE
Pik And Paste	79
Paste Dispenser	79
Vacuum Pick	86
MicroChine	89
Set-Up	89
Probe Brake Operation	90
Pulse Plate	93
Set-Up	93
Pulse Heat	97
Set-Up	97
Operation	99
Reference Guidelines	100
Corrective Maintenance	103
VisiFilter Element Replacement	103
Handpieces	104
Power Source	106
Replacement Parts	112
Power Source	112
System Packaging	113
System Handpieces	114
System Accessories	115
SensaTemp Handpieces	116
Manual Improvement & Comment Form	115
Warranty	117



PACE, INCORPORATED RETAINS THE RIGHT TO MAKE CHANGES TO SPECIFICATIONS CONTAINED HEREIN AT ANY TIME, WITHOUT NOTICE.

THE FOLLOWING ARE REGISTERED TRADEMARKS AND/OR SERVICE MARKS OF PACE, INCORPORATED, LAUREL, MARYLAND, USA AND MAY ONLY BE USED TO IDENTIFY GENUINE PACE PRODUCTS OR SERVICES.

ARM-EVAC[®], Flo-D-Sodr[®], Mini-Wave[®], PACE[®], SensaTemp[®], Snap-Vac[®], SODRTEKSM, Sodr-X-Tractor[®], THERMO-DRIVE[®], ThermoFlo[®], ThermoJet[®], ThermoTweeze[®], TOOLNET[®], VisiFilter[®], PERMAGROUNDTM, Tip-BriteTM, Auto-OffTM

Additional copies of this manual or other PACE literature may be obtained from:



PACE Incorporated
255 Air Tool Drive
Southern Pines,
North Carolina, 28387
Tel: (877) 882-PACE
Tel: (910) 695-7223
Fax: (910) 695-1594

Pace Europe
11 Holdom Avenue
Bletchley, Milton Keynes,
United Kingdom, MK11QU
Tel: 011 44 1908 277666
Fax: 011 44 1908 277777



USE OF THIS MANUAL

The information contained in this manual will provide the user with the basic knowledge necessary to properly operate and maintain the PACE model PRC 2000 system. The additional manuals included with your system will provide the user with specific operational features of the associated accessory. PACE STRONGLY RECOMMENDS THAT THE USER READ AND FULLY UNDERSTAND THE "OPERATION" PORTIONS OF THIS MANUAL PRIOR TO USE OF SYSTEM IN COMPONENT REMOVAL/ REPLACEMENT OPERATIONS. The "Quick Reference-System Operation" Guide is provided as a convenient reference for day-to-day operation of the Thermal Management Center portion of this system. If you encounter any difficulty operating your system, call your local authorized PACE distributor or contact PACE Applications Engineering directly at Tel. (301) 490-9860 or FAX (301) 604-8782.

INTRODUCTION

The PRC 2000 is a Process Control System for Universal Assembly and Repair of Electronic Assemblies. The systems include the power source with a selection of accessories and functional aids. The systems are available in a variety of package configurations to suit your needs.

The PRC 2000 systems are available in either the 100 VAC version, the 115 VAC version or the 230 VAC version. The Power Source houses five functional sections. The following is a brief description of each section.

The PRC 2000 **THERMAL MANAGEMENT CENTER** incorporates outputs for specialized SensaTemp handpieces for safe installation and removal of virtually all surface mount and thru-hole components. Three auxiliary channels provide SensaTemp control of separately sold AC line-powered accessories. Continuous automatic calibration, auto power down and a built-in software password function assure consistent operator performance, reliability and security.

The **PIK AND PASTE** section features a self-contained high pressure air supply with timing control for precise dispensing of solder paste and other materials. The vacuum pick has a finger actuated release for convenient component handling.

The PRC 2000 **MICROCHINE** is a lightweight, variable speed machining handpiece for precise circuitry and substrate repair. With its tachometer feedback, the MicroChine can maintain controlled drilling and milling rates under varying loads. The MicroChine's patent pending **PROBE BRAKE** feature instantly stops machining at a selected layer depth for safe multilayer repair.

The **PULSE HEAT** section provides variable controlled, low voltage AC pulse power to an array of specialized handpieces for safe surface mount rework, circuitry repair, auxiliary heating, coating removal and thermal wire stripping.



INTRODUCTION CONT'D

The **PULSE PLATE** section provides variable controlled DC pulse power for high-quality cleaning and electroplating of edge connectors and other circuit contacts with nickel, gold and other metals.

The SR-4 "Safety Rating" designation on the back panel is your assurance that the PRC 2000 meets or exceeds all applicable civilian and military standards (including MIL-STD-2000A, and WS-6536), EOS\ESD and worldwide electrical codes. The 230 VAC version system bears the CE Conformity Marking which assures the user that it conforms to all the requirements of council directive EMC 89/336/EEC. The 115 VAC version system bears the FCC Conformity Marking which assures the user that it conforms to all the requirements of FCC Emission Control Standard, Title 47, Part 15, Subpart B, Class A.

SPECIFICATIONS

POWER REQUIREMENTS

PRC 2000 (PPS 400 power source): Version operates on 97-127 VAC, 60 Hz. 250 Watts.

PRC 2000J (PPS 400J power source): Version operates on 90-115 VAC, 50/60 Hz. 250 Watts.

PRC 2000E (PPS 400E power source): Version operates on 195-264 VAC, 50/60 Hz. 365 Watts.

PHYSICAL PARAMETERS

Size: 35 cm W x 17.5 cm H x 23 cm D (13.75 in W x 6.9 in H x 9.25 in D)

Weight: 13.6 Kg (30 Lbs)

ENVIRONMENTAL REQUIREMENTS

Ambient Operating Temperature: 0°C to 50°C (32°F to 120°F).



Storage Temperature: -40°C to 100°C (-40°F to 212°F).

THERMAL MANAGEMENT CENTER

VACUUM AND AIR

Measurements at front panel **SNAP-VAC** and Controllable **PRESSURE** Ports of power source.

Vacuum Rise Time:	Evacuates 33 cc (2 cubic inches) volume to 25 cm Hg. (10 in. Hg.) in 150 ms.
Vacuum:	51 cm Hg. (20 in. Hg.) (nominal)
Pressure:	48 Bar (7 P.S.I.) (nominal MAX setting)
Air Flow:	13 SLPM (0.46 SCFM) maximum.

TEMPERATURE SPECIFICATIONS

Tip Temperature Range: 38°C to 482°C (100°F - 900°F) (see note).

Digital Readout Resolution: ± 1° (°C or °F)

Tip Temperature Stability: ± 1.1 °C (2°F) at idle from Set Tip Temperature.

NOTE
True minimum and maximum Operating Tip Temperatures may vary depending on handpiece & tip selection.

EOS/ESD

Tip-To-Ground Resistance:	Less than 5 ohms.
AC Leakage:	Less than 2 millivolts RMS from 50Hz to 500Hz, min.



CAPABILITIES

Your new PRC 2000 is the most advanced, self-contained rework and repair system ever created for the service bench or manual production workstation. The case's T-slot channels allow you to configure PRC 2000 accessories to suit individual operator preferences. The new style Tip & Tool Stands and Hot Cubbies can be mounted to the T-slot channels or set up freestanding (with the purchase of optional "Stand Alone" cubby upgrades for Hot Cubbies). This offers great versatility when the unit is shared by several operators who may have different layout preferences.

PRIMARY CONTROLS

In the upper left hand corner, you will find the master **POWER** Switch which controls all power to the unit. Just to the right of the **POWER** Switch is a 4-position **FOOT PEDAL** Selector Switch which directs the action of the foot pedal connected to the **FOOT PEDAL** Receptacle (rear panel). This ensures that only one of the listed functions is activated by the foot pedal at any one time. The switch positions are as follows:

PH - Pulse Heat,
PP - Pulse Plate,
MC - MicroChine,

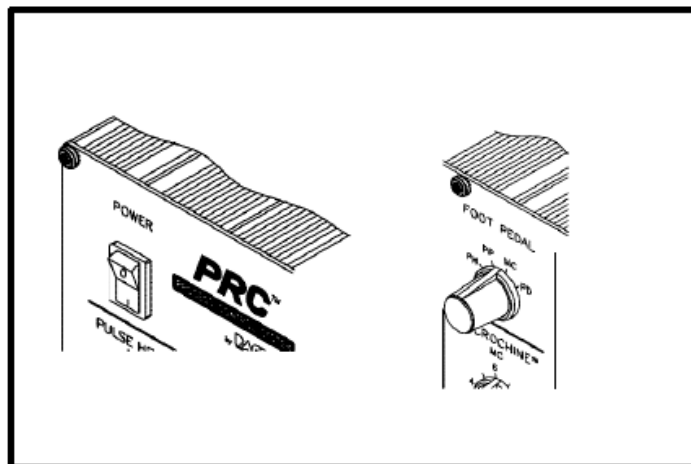

Figure 1. Primary Controls **PD** - Paste Dispenser.

NOTE

Although vacuum and air pressure to air-operated SensaTemp handpieces is controlled by finger actuated handpiece switches, a second foot pedal can be connected to any Auxiliary (**AUX**) channel receptacles (rear panel) of the **THERMAL MANAGEMENT CENTER** to control vacuum or air pressure to these handpieces.



PULSE HEAT

At the lower left of the control panel you will find the **PULSE HEAT** section of the PRC 2000. The two AC jacks are for connecting the Universal Power Cord to the PRC 2000 system. The cord will accept several quick connect/disconnect handpieces including the LapFlo, ResisTweez, ConducTweez (optional) and StripTweez (optional) which can be changed within 2 seconds. Pulse Heat handpieces with non-solderable, rapid heat up/cool down tips offer unique advantages in many SMT rework, conformal coating removal, soldering and auxiliary heating applications. With many Surface Mount Devices (SMDs) it is not only important to achieve the solder reflow temperature, but to control the way in which you arrive at that temperature. Many of the newer SMDs are very sensitive to thermal shock and overheating. The intrinsic slow temperature ramp-up (rise time) of the Pulse Heat handpieces provide an extra measure of safety for such components. Always consult your organization's specifications or the component manufacturer's guidelines. Some very sensitive components may require controlled preheating (e.g., with the PACE HotSpot temperature controlled heating surface).

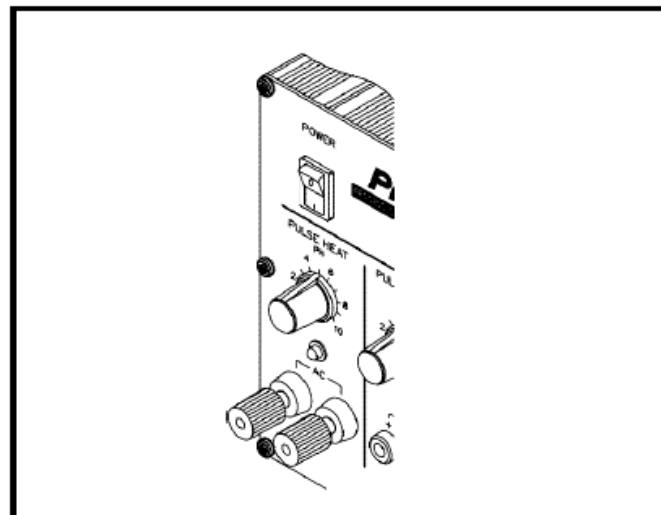

Figure 2. Pulse Heat Section



NOTE

The ResisTweez resistance soldering handpiece by its very nature may have a potential leakage voltage above 2mV. Its use should be restricted to soldering and auxiliary heating applications in which there is no risk of electrical over stress (EOS) discharge damage to sensitive components. PACE ThermoBand tips, which fit the ResisTweez, are specially insulated to keep leakage below 2mV.

The control knob located above the AC terminals (**PULSE HEAT** Output Control) controls the amount of energy delivered to the handpieces. The Green LED will light to indicate that current is flowing to the handpiece when the foot pedal has been depressed.

PULSE PLATE

The **PULSE PLATE** section located just to the right of the **PULSE HEAT** section allows the operator to safely replate damaged, worn or repaired connectors, circuit contacts and edge connectors using simple plating solutions. The swab plating probe and ground clip connect to the terminals labeled "DC" while the control knob can be adjusted to regulate the amount of voltage applied to the area being plated. The Green LED will light to indicate that voltage is being applied when the foot pedal is depressed. The LED will shift from Green to Red if an overcurrent condition is reached. Contact your local PACE representative for information regarding the optional PE-210 SwaPlating accessory (P/N 7003-0002) to the PRC 2000 system.

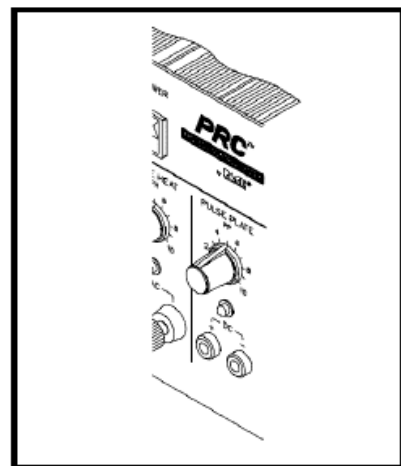

Figure 3. Pulse Plate Section

MICROCHINE

The **MICROCHINE** represents the latest PACE development in hand machining for the circuit board rework and repair. The self-contained motor handpiece connects to the PRC 2000 via a special connector. The motor unit can be actuated by a fingertip control switch or the foot pedal. A tachometer feedback loop between the motor and controller keeps the speed that you select constant as the load on the motor changes. Below and to the right of the **MICROCHINE** you will find a connection jack labeled "**PROBE BRAKE**" which offers additional control of milling and drilling operations. Connecting the probe to a conductive element where you wish machining to stop will cause the motor to stop immediately as soon as contact is made. This feature can also be used to protect other circuit elements (e.g., adjacent lands or circuit traces) when machining in the tight spaces often found on today's circuit assemblies. The LED will light Green when the unit is running and Red when the probe brake has been activated. The LED will shift its color from Green to Yellow when the motor has reached its maximum load. This is normally an indication that too much pressure is being applied to the workpiece. The control knob regulates the speed of the motor unit so that it can be easily set for the work to be performed. The MicroChine uses the same collet previously found in the PACE MiniChine systems, so that all existing bits will be interchangeable and features the same special static dissipative housing material found in all PACE soldering/desoldering handpieces. An optional chuck is available to accommodate variable shank diameter bits.

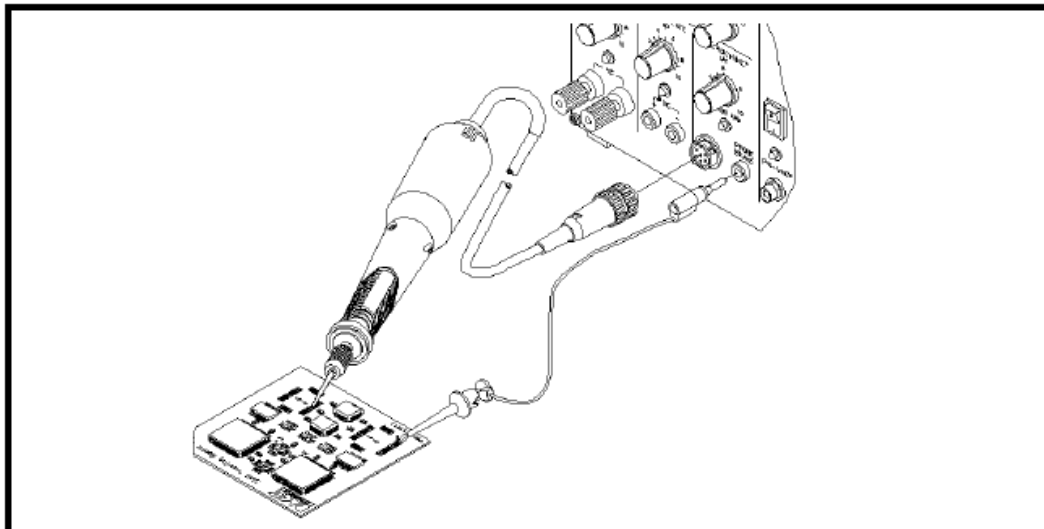

Figure 4. MicroChine Section



PIK AND PASTE

Located in the middle of the front panel, you will find the **PIK AND PASTE** section of the PRC 2000. The Pik-Vac feature provides a quiet and gentle vacuum source to the Pik-Vac wand for use in handling and placing your surface mount parts. Turning on the **PIK-VAC** Power Switch will cause a continuous vacuum to be made available to the pick. A variety of tip and vacuum cups are supplied to handle most surface mount parts. The Green LED will light to indicate when the **PIK-VAC** is running. There is also a low pressure auxiliary **PIK PRESSURE** Port located on the rear panel which can be used to operate low pressure accessories such as a sprayer.

The paste dispensing system occupies the right half of the **PIK AND PASTE** section of the PRC 2000 and can dispense a variety of solder cremes, fluxes, potting compounds and adhesives. The Paste Dispense air hose comes equipped to accept standard 10cc material barrels. The self-contained pump supplies nominal 40psi (.28 MPa) of air pressure to the syringe. Above the **PASTE DISP** Port, you will find a 2-position switch labeled **TIMED** and **CONT** (Continuous). In the continuous (**CONT**) position the dispenser pump will supply continuous air pressure to the syringe while the foot pedal remains depressed (**FOOT PEDAL** Selector Switch in "**PD**" position). In the "**TIMED**" position, the control knob above the switch becomes active. Each depression of the foot pedal will activate the pump from 0.1 to 10 seconds. The LED will light Yellow to indicate when the pump is running and will shift to Green when air pressure is being applied to the syringe.

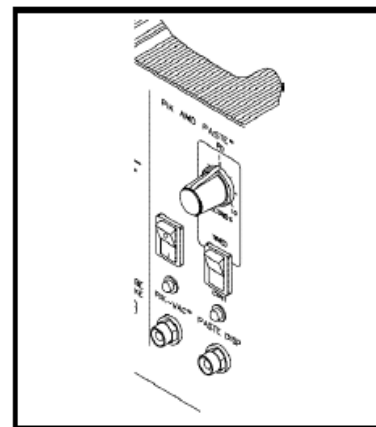

Figure 5. Pik And Paste Section

NOTE

Whenever the **FOOT PEDAL** Selector Switch is in the "**PD**" position, the pump will periodically run for short periods to maintain internal pressure. The pump will continue to run (Yellow LED lit) while the system recharges.

NOTE

As with any dispensing system, when thick viscous material or solder paste is to be dispensed, ensure that the material is fresh, has been stored properly and is at room temperature as per supplier's recommendations.



THERMAL MANAGEMENT CENTER

The **THERMAL MANAGEMENT CENTER** occupying the right 1/3 of the front panel is the heart of your PRC 2000 system. This microprocessor based multi-channel center can control up to six devices at one time. To the left of the Digital Readout are the three LEDs which indicate the "Current Channel" (i.e., the channel whose temperature information can be adjusted and is displayed on the Digital Readout (**CH 1**, **CH 2** and **CH 3**)). Below these is the Green **AUX** (Auxiliary) LED. When this LED is lit in conjunction with one of the channel LEDs, the Digital Readout displays temperature information of the three auxiliary channels located on the rear panel. To the right of the Digital Readout is the °F/°C Key which allows the operator to switch instantly between a ° F and ° C display. Located just below the Digital Readout is an array of five keys. In normal operation, these keys control channel selection, tip temperature and tip temperature offset settings. The two keys with up and down arrows are used for scrolling the temperature and offset settings up and down. The LEDs located above the **SET** and **OFFSET** Keys normally indicate which function is being adjusted. In Calibration (CAL) Mode, these same keys are also used for entering, setting and clearing the password features as well as adjusting temperature parameters and system set-up. By entering the tip temperature offset and the tip temperature, the true tip temperature will be displayed on the Digital Readout. All these features will be discussed in the operation section of the manual. Below the keys are three receptacles for attaching any three low voltage SensaTemp handpieces in any configuration up to 100 watts/channel (300 watts total) power. There are three additional receptacles on the lower left section of the rear panel. These will accept up to three additional, externally powered, devices which are temperature controlled by the **THERMAL MANAGEMENT CENTER**. As an alternative, any of the rear panel receptacles can accept a foot pedal which will control the internal vacuum/pressure pump in addition to using the finger-actuated switches found on the SensaTemp handpieces. SensaTemp handpieces available for use with your PRC 2000 include:

SP-2A Sodr-Pen Soldering Iron, SP-
1A Sodr-Pen Soldering Iron, SX-70
Sodr-X-Tractor Handpiece, TT-65
ThermoTweez Handpiece, TP-65
ThermoPik Handpiece,
DTP-80 Dual ThermoPik Handpiece, TJ-
70 Mini ThermoJet Handpiece.

Just to the left of the three **SENSATEMP** receptacles is a grounding jack which will accept a standard banana plug. This can be used for grounding the operation, the work or additional equipment. To the right of the **SENSATEMP** receptacles you will find the **SNAP-VAC** Vacuum and Controllable **PRESSURE** Ports. The **SNAP-VAC** Port (bottom) should always have a VisiFilter attached in order to protect the vacuum pump from any ingested material and to help muffle noise when the motor is running. The Controllable **PRESSURE** Port (top) is used to supply air to the Mini ThermoJet handpiece. The rate of delivered air flow

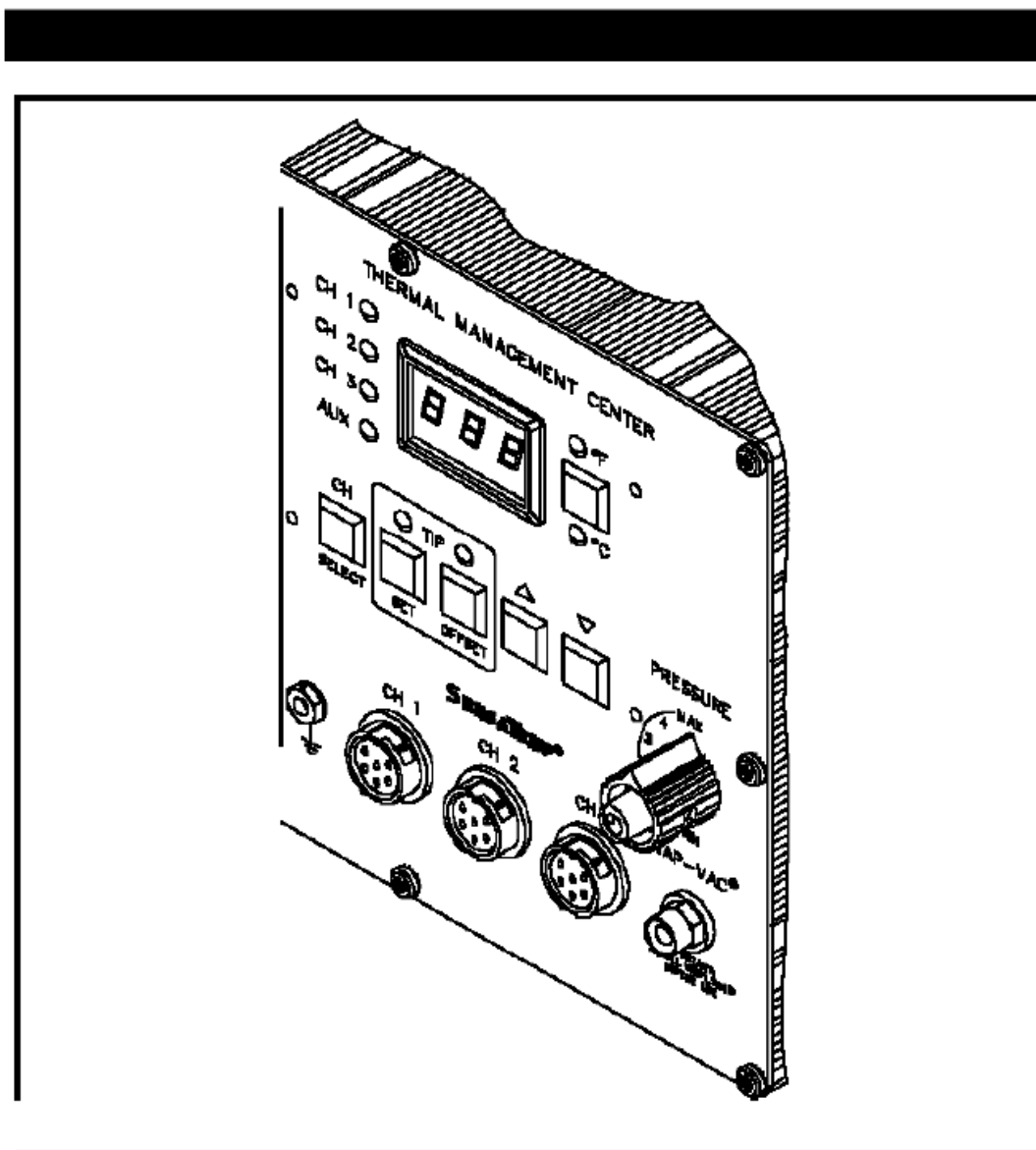

Figure 6 Thermal ManagementCenter

PARTS IDENTIFICATION

SYSTEM

1. **POWER SWITCH** - Turns system ON ("1") and OFF ("0"); controls input power to the system.
2. **FOOT PEDAL SELECTOR SWITCH** - Control knob provides foot pedal connection to Pik and Paste (**PD**), MicroChine (**MC**), Pulse Plate (**PP**) or Pulse Heat (**PH**) features.

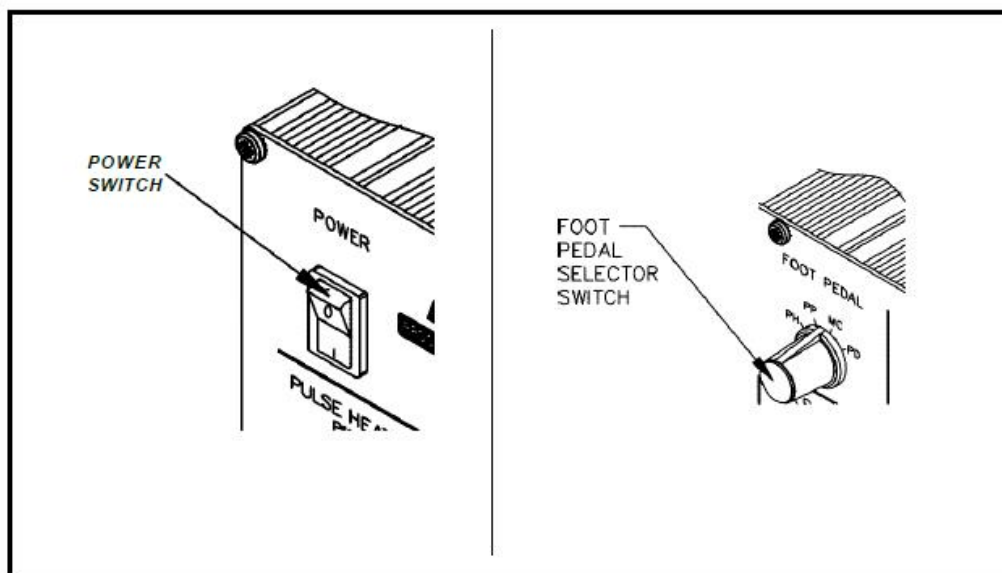

Figure 8. Power Switch/Foot Pedal Selector Switch

FRONT PANEL FEATURES

PULSEHEAT

- 3. PULSE HEAT OUTPUTS** - Low voltage AC power outputs for Low Voltage, Pulse Heat handpieces.
- 4. PULSE HEAT OUTPUT CONTROL** - Controls low voltage AC power at **PULSE HEAT** Outputs.
- 5. PULSE HEAT LED** - Illuminates Green in color when power is applied (by foot pedal through **FOOT PEDAL** Selector Switch) to the **PULSE HEAT** Outputs.

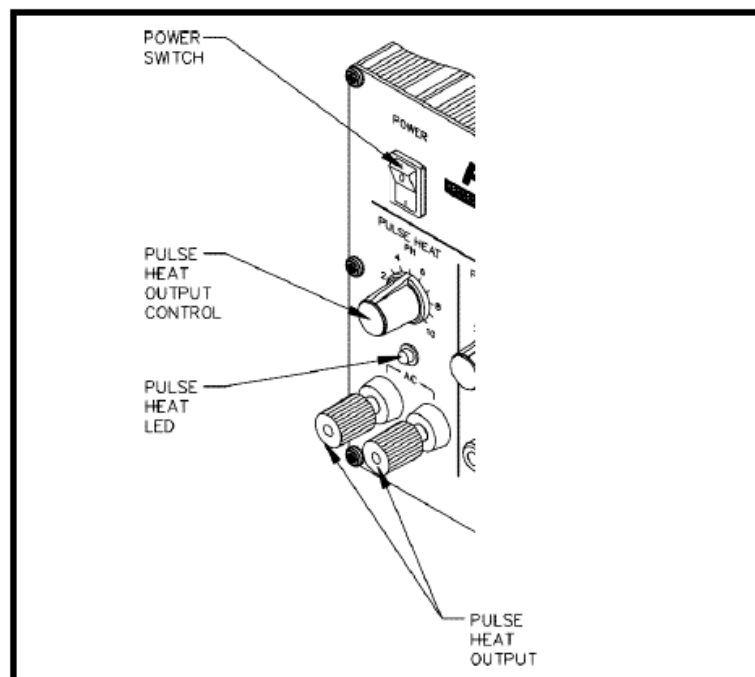

Figure 9. Pulse Heat Section



PULSEPLATE

6. **PULSE PLATE OUTPUTS** - DC power connections for PACE SwaPlater plating system.
7. **PULSE PLATE OUTPUT CONTROL** - Controls DC power at **PULSE PLATE** Outputs.
8. **PULSE PLATE LED** - Illuminates Green to indicate when power is applied (upon foot pedal actuation) at the **PULSE PLATE** Outputs. Illuminates Red if an overcurrent condition occurs during plating.

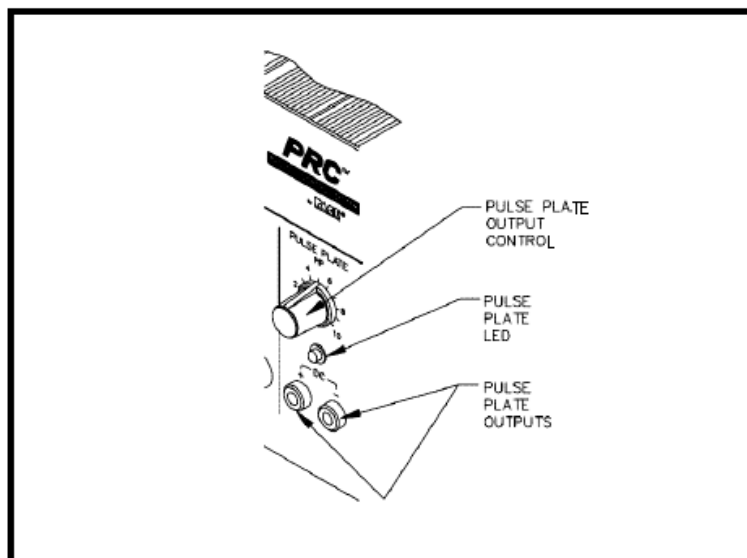

Figure 10. Pulse Plate Section

MICROCHINE

9. **MICROCHINE POWER RECEPTACLE** - Provides power, speed control, tip ground and finger switch connection for the MicroChine handpiece.
10. **VARIABLE SPEED CONTROL** - Controls motor speed (2,500 - 10,000 RPMs) of MicroChine handpiece.
11. **PROBE BRAKE RECEPTACLE** - Provides Probe Brake connection for the MicroChine Probe Brake feature. See MicroChine portion of this manual for details.
12. **STATUS LED** - Illuminates Green to indicate MicroChine operation. Illuminates Amber if maximum torque load is reached. Illuminates Red to indicate braking status when Probe Brake circuit is activated.

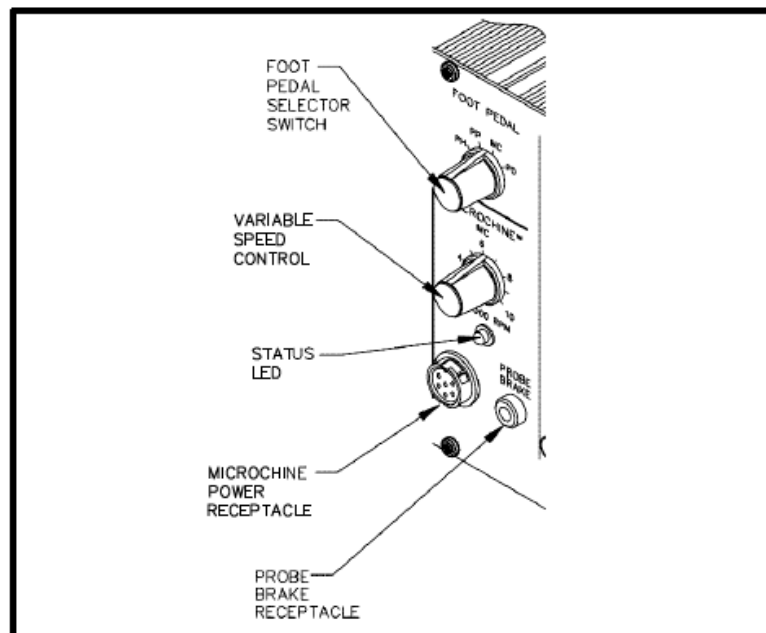

Figure 11. MicroChine Section



PIK AND PASTE

13. **PIK-VAC POWER SWITCH** - Turns power "ON" (1) or "OFF" (0). Controls power to the Pik-Vac vacuum pump.
14. **PIK-VAC LED** - Illuminates Green to indicate Pik-Vac vacuum pump operation.
15. **PIK-VAC PORT** - Quick connect fitting which provides vacuum for Pik-Vac handpiece.
16. **PIK AND PASTE TIMER CONTROL** - Determines variable time controlled shot (0.1 - 10 seconds) of Paste Dispense (**PASTE DISP**) air pressure upon foot pedal actuation (Foot Pedal Selector Switch in "PD" position). Operates when **TIMED/CONT** Switch is in the "**TIMED**" position.
17. **TIMED/CONT SWITCH** - In **CONT** position, continuous air pressure is delivered from **PASTE DISP** Port upon foot pedal actuation (Foot Pedal Selector Switch in **PD** position). In "**TIMED**" position, measured interval of air pressure (0.1 - 10 seconds) is delivered from **PASTE DISP** Port upon foot pedal actuation (Foot Pedal Selector Switch in **PD** position).
18. **PASTE DISP LED** - Illuminates Green when air pressure is delivered from the **PASTE DISP** Port. Illuminates Yellow when the paste dispense pump reservoir is charging (no air pressure delivery from **PASTE DISP** Port).
19. **PASTE DISP PORT** - Quick connect fitting which provides air pressure (timed or continuous) to dispensing barrel.



THERMAL MANAGEMENT CENTER

Refer to the illustration following for location of parts.

20. **CH 1 POWER RECEPTACLE** - Provides power, tip ground, sensing circuitry and finger switch connection from PRC 2000 system to handpiece connected to Channel 1 (**CH 1**).
21. **CH 2 POWER RECEPTACLE** - Provides power, tip ground, sensing circuitry and finger switch connection from PRC 2000 system to handpiece connected to Channel 2 (**CH 2**).
22. **CH 3 POWER RECEPTACLE** - Provides power, tip ground, sensing circuitry and finger switch connection from PRC 2000 system to handpiece connected to Channel 3 (**CH 3**).
23. **SNAP-VAC PORT** - Quick connect fitting which provides quick-rise vacuum for Sodr-X-Tractor or ThermoPik handpieces.
24. **CONTROLLABLE PRESSURE PORT** - Quick connect fitting with adjustable valve which provides variable air flow for Mini ThermoJet handpiece and Sodr-X-Tractor handpiece (in HotJet Mode).
25. **DIGITAL READOUT** - Provides a three digit display of the Current Channel (channel with illuminated LED; **CH 1**, **CH 2**, **CH 3** or **AUX 1**, **AUX 2**, **AUX 3**) temperature information. This includes: Operating Tip Temperature in Temperature Display Mode (normal operation), Tip Temperature Offset Constant in **TIP OFFSET** Mode, Set Tip Temperature in **TIP SET** Mode, and other information in Calibration (CAL) Mode.
26. **°F/°C KEY** - Selects °F or °C display of Set and Operating Temperatures and Tip Temperature Offset Constants.
27. **°F LED** - Illuminates when Set and Operating Tip Temperatures and Tip Temperature Offset Constants are displayed in °F.
28. **°C LED** - Illuminates when Set and Operating Tip Temperatures and Tip Temperature Offset Constants are displayed in °C.
29. **CH 1 LED** - Illuminates when Channel 1 (**CH 1**) or Auxiliary Channel (**AUX 1**) is the Current Channel (i.e., the channel (with connected handpiece/tip or auxiliary accessory) whose temperature information is displayed on the Digital Readout).



30. **CH 2 LED** - Illuminates when Channel 2 (**CH 2**) or Auxiliary Channel (**AUX 2**) is the Current Channel (i.e., the channel (with connected handpiece/tip or auxiliary accessory) whose temperature information is displayed on the Digital Readout).
31. **CH 3 LED** - Illuminates when Channel 3 (**CH 3**) or Auxiliary Channel (**AUX 3**) is the Current Channel (i.e., the channel (with connected handpiece/tip or auxiliary accessory) whose temperature information is displayed on the Digital Readout).
32. **AUX LED** - Illuminates when an auxiliary channel (on system rear panel) is the Current Channel (i.e., the channel (with connected handpiece/tip or auxiliary accessory) whose temperature information is displayed on the Digital Readout). One of the **CH 1**, **CH 2** or **CH 3** LEDs will illuminate simultaneously with the Auxiliary LED to indicate, respectively, which of the auxiliary channels is active (**AUX 1**, **AUX 2** or **AUX 3**).
33. **CH SELECT KEY** - Selects the Current Channel (among "Active Channels" (i.e., those with a connected handpiece or auxiliary accessory)).
34. **TIP SET KEY** - Allows the operator to adjust the Set Tip Temperature for the handpiece/tip combination or Set Temperature for the auxiliary accessory connected to the Current Channel. Places the **THERMAL MANAGEMENT CENTER** in the **TIP SET** (Tip Temperature Set) Mode.
35. **TIP SET LED** - Flashes when **TIP SET** Key is pressed indicating that the **THERMAL MANAGEMENT CENTER** is in **TIP SET** Mode.
36. **TIP OFFSET KEY** - Allows the operator to adjust the **TIP OFFSET CONSTANT** for the handpiece or auxiliary accessory connected to the Current Channel. Places the **THERMAL MANAGEMENT CENTER** in the **TIP OFFSET** (Tip Temperature Offset) Mode.
37. **TIP OFFSET LED** - Flashes when **TIP OFFSET** Key is pressed indicating that the **THERMAL MANAGEMENT CENTER** is in the **TIP OFFSET** Mode. Remains illuminated (not flashing) in Temperature Display Mode (normal operating mode) when a Tip Temperature Offset Constant of greater than "3" for °C ("6" for °F) is entered.
38. **SCROLL UP KEY** - Increases the Set Tip Temperature (in **TIP TEMPERATURE SET** Mode) and Tip Temperature Offset Constant (in **TIP TEMPERATURE OFFSET** Mode) in one, then ten degree increments. Also used in "CAL" (Calibration) Mode.

39. SCROLL DOWN KEY - Decreases the Set Tip Temperature (in **TIP SET** Mode) and Tip Temperature Offset Constant (in **TIP OFFSET** Mode) in one, then ten degree increments. Also used in "CAL" (Calibration) Mode.

40. EARTH GROUND RECEPTACLE - Provides positive earth ground to which a ground cable can be connected from the workpiece or work surface as part of a static control program.

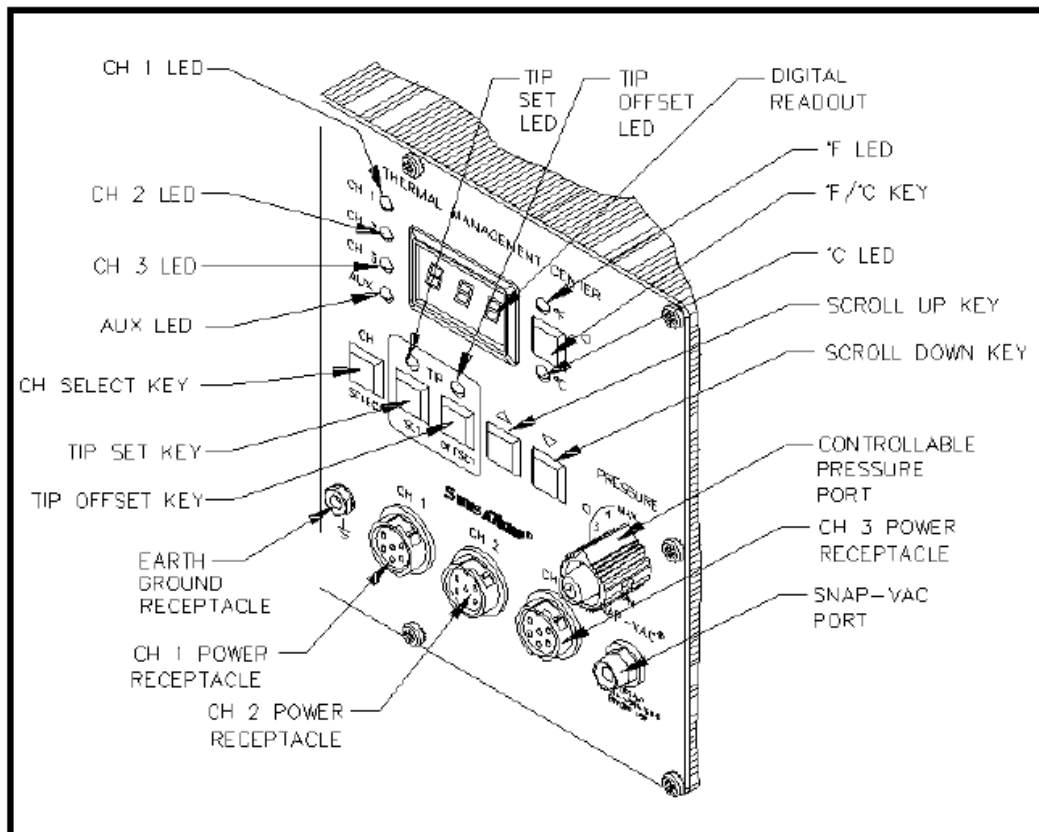

Figure 13. Thermal Management Center Parts I.D.



REAR PANEL

- 41. **AC POWER RECEPTACLE/FUSE HOLDER** - Receptacle for providing power to the PRC 2000 system from AC outlet through power cord. Also location of fuse (F1) which protects the system from overcurrent conditions.
- 42. **FUSE F1** - Provides overload protection for PRC 2000 system.
- 43. **FOOT PEDAL RECEPTACLE** - Input for foot pedal which operates the Pik and Paste, MicroChine, Pulse Plate or Pulse Heat features of the system as determined by the **FOOT PEDAL** Selector Switch.

NOTE

The Auxiliary Power Receptacles listed below (items 44-46) will provide temperature control for line operated auxiliary accessories or foot pedal operation only. **SensaTemp handpieces will not function properly if connected to these outputs.**

- 44. **AUX 1 POWER RECEPTACLE** - Provides temperature control, tip ground sensing circuitry and finger switch connection from **THERMAL MANAGEMENT CENTER** to the auxiliary accessory connected to Auxiliary Channel 1. Foot pedal attachment to this receptacle will allow vacuum/pressure pump operation through foot pedal actuation.
- 45. **AUX 2 POWER RECEPTACLE** - Provides temperature control, tip ground sensing circuitry and finger switch connection from **THERMAL MANAGEMENT CENTER** to the auxiliary accessory connected to Auxiliary Channel 2. Foot pedal attachment to this receptacle will allow vacuum/pressure pump operation through foot pedal actuation.
- 46. **AUX 3 POWER RECEPTACLE** - Provides temperature control, tip ground sensing circuitry and finger switch connection from **THERMAL MANAGEMENT CENTER** to the auxiliary accessory connected to Auxiliary Channel 3. Foot pedal attachment to this receptacle will allow vacuum/pressure pump operation through foot pedal actuation.
- 47. **FUSE F2** - Provides overload protection for **CH 1**, **CH 2** and **CH 3** power receptacles.
- 48. **PIK PRESSURE PORT** - Low pressure output with quick connect fitting. Controlled by **PIK-VAC** Power Switch (front panel).

- 49. TIP & TEMPERATURE SELECTION SYSTEM CHART HOLDER (NOT SHOWN) -**Holds PACE's Tip & Temperature Selection System charts (booklet) which enable the operator to accurately set and display the true, correct operating tip temperature for any handpiece/tip configuration connected to CH 1, CH 2 or CH 3.

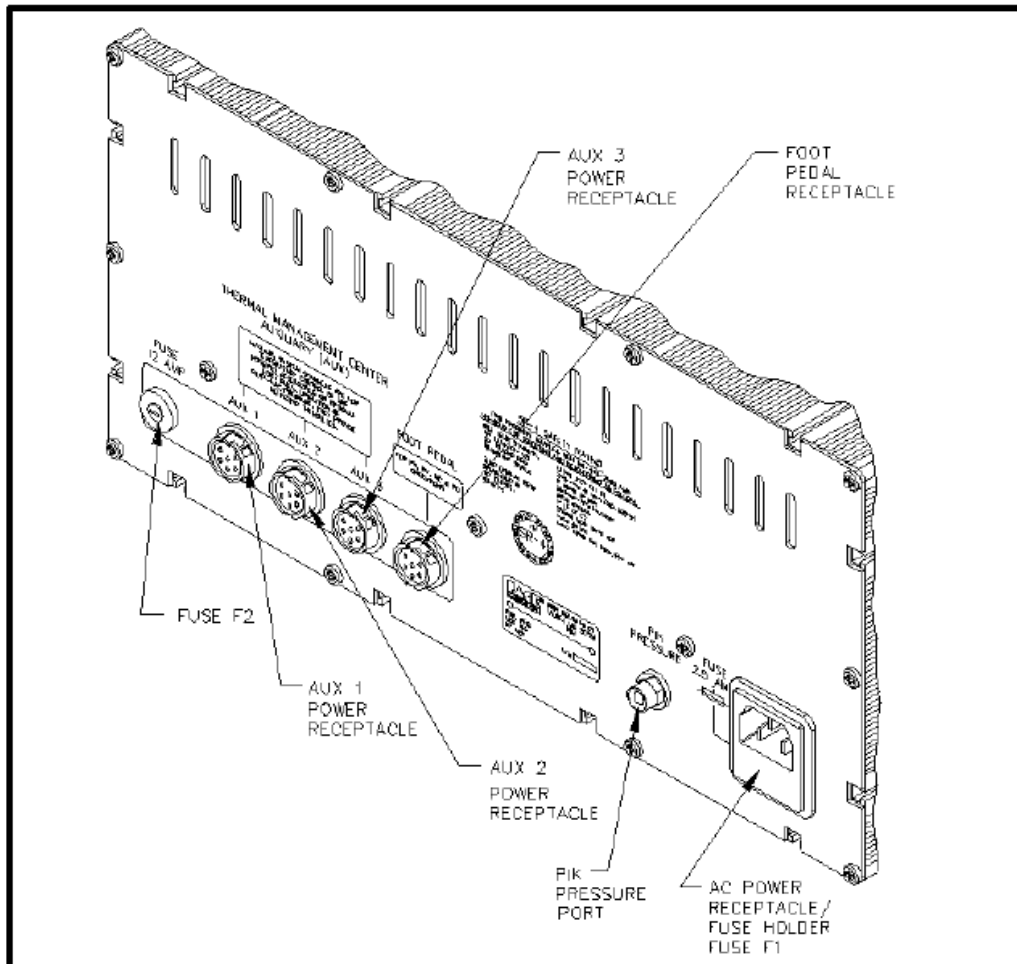

Figure 14. Rear Panel Parts I.D.



PRECAUTIONS

The following are general safety precautions which personnel must understand and follow when using or servicing this product. These precautions may or may not be included elsewhere in this manual.

USAGE PRECAUTIONS

CAUTIONS

1. SensaTemp handpiece heaters and installed tips are hot when handpiece is powered on. DO NOT touch either the heater or tip. Severe burns may result! Always store handpiece in the appropriate Tip & Tool Stand or cubby when not in use.
2. Always use this system in a well ventilated area. A fume extraction system such as those available from PACE are highly recommended to protect personnel from solder flux fumes.
3. Exercise proper precautions when using chemicals (e.g., solder paste). Refer to the Material Safety Data Sheet (MSDS) supplied with each chemical and adhere to all safety precautions recommended by the manufacturer.

NOTES

1. The solder collection chamber in the PACE Sodr-X-Tractor is made of glass. Never remove this chamber using pliers. Breakage of the chamber may result. Always remove using the procedures recommended by PACE in the associated handpiece manual.
2. The front end (heater end) of the glass solder collection chamber in the PACE Sodr-X-Tractor is hot when the handpiece is in use. When removing the chamber for cleaning, grip the chamber at the rear seal. Never touch the front end of the glass chamber with bare hands. Allow the chamber to cool before cleaning.
3. Always store any connected handpiece in the appropriate Tip & Tool Stand or cubby.

SERVICING PRECAUTIONS

DANGERS

POTENTIAL SHOCK HAZARD - Repair procedures performed on this product should be performed by qualified service personnel only. Line voltage parts will be exposed when equipment is disassembled. Service personnel must avoid contact with these parts when troubleshooting the power source.

NOTES

Refer to the PRC 2000 Service Manual (P/N 5050-0344) whenever service is required.



To insure continued peak performance, use genuine PACE replacement parts.



SYSTEM

Set up the PRC 2000 system using Figures 15 through 18 and the following steps.

1. Store the shipping container(s) in a convenient location. Reuse of these containers will prevent damage if you ship or store the system.
2. Place **POWER** Switch in the "OFF" or "0" position.
3. Position the system on a convenient bench.
4. Insert the power cord into AC Power Receptacle at the rear panel of the system.

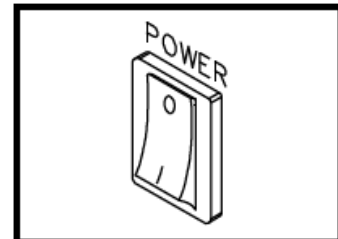

Figure 15. Power Off

CAUTION

To insure operator safety, the AC supply receptacle must be checked for proper grounding before initial operation.

5. Assemble and attach Tip & Tool Stands & Hot Cubbies to the power source. Assembly instructions are enclosed with each Tip & Tool Stand and Hot Cubby.
6. Using Figure 16 as a guide, install the Tip & Temperature Selection System Chart Holder to the top of the power source.
7. Install the Tip & Temperature Selection System Chart booklet onto the Chart Holder.
8. Place handpiece(s) into the Tip & Tool Stands and Hot Cubbies.

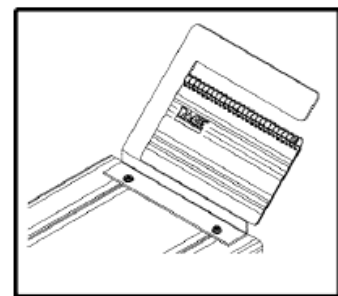

Figure 16. Chart Holder



SYSTEM CONT'D

9. Connect handpiece connector plug(s) to **THERMAL MANAGEMENT CENTER (TMC)** Power Receptacle(s) **CH 1**, **CH 2** and/or **CH 3** as follows.
 - a) With the Connector Key end facing the power source, turn the Locking Ring fully counterclockwise.
 - b) Align Connector Key with Receptacle Keyway of Power Receptacle.
 - c) Insert connector into Power Receptacle.
 - d) Turn Locking Ring fully clockwise to lock in place.

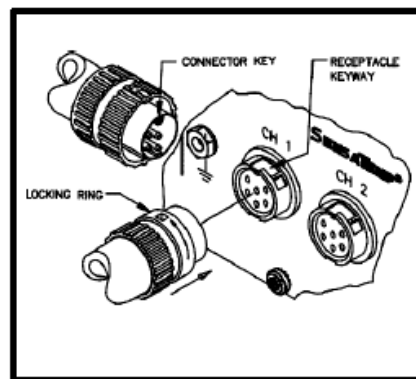

Figure 17. TMC Handpiece Connection

10. To avoid confusion among handpieces, PACE recommends the use of colored markers (P/N 6993-0136 Cable Marker Kit) to identify the particular handpiece power cord and/or air hose. Attach any two like colored markers, one to each end of the handpiece power cord or air hose. Select and use a different colored marker for each handpiece. Labels are also provided to mark Tip & Tool Stands and Hot Cubbies with the name of the associated handpiece.

Receptacle on rear panel of power source to enable foot pedal operation of **MICROCHINE (MC)**, **PIK AND PASTE (PD)**, **PULSE HEAT (PH)** and **PULSE PLATE (PP)** features (as selected by position of **FOOT PEDAL** Selector Switch).

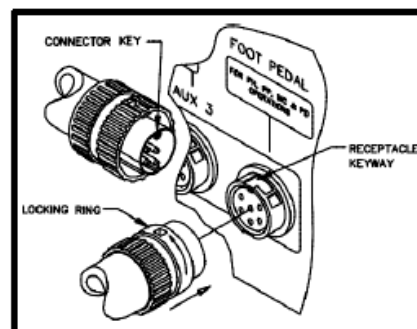

Figure 18. Foot Pedal Connection

12. Install additional handpieces and accessories as necessary using the "Set-Up" instructions and the manual supplied with each handpiece.
13. Plug the prong end of the power cord into a convenient three wire grounded AC power outlet. The system is now ready for operation.
14. Read the "OPERATION" section of this manual



32 thoroughly before operating the system.



HANDPIECE VACUUM/PRESSURE

The SX-65A, SX-70 and TP-65 handpieces require the use of the **SNAP-VAC** (vacuum) Port and the TJ-70 handpiece requires the use of the Controllable **PRESSURE** Port on the **THERMAL MANAGEMENT CENTER (TMC)**.

There are two preferred methods for connection of the Air Hose. The advantages of each method are discussed in the paragraph below. Select the method best suited to your particular application.

1. **TRADITIONAL METHOD** - Best suited for single air handpiece configurations. Configuration allows the air hose to be attached to the handpiece power cord. Any TJ-70 Mini ThermoJet handpiece should be configured using this method.
2. **QUICK CONNECT METHOD** - Best suited for **THERMAL MANAGEMENT CENTER** configurations which include multiple air handpiece attachment. A single Air Hose can be easily transferred between handpieces using quick connect fittings attached to the rear of each handpiece.

PROCEDURES:

TRADITIONAL METHOD

1. Connect the 54 inch (137cm) length of Air Hose to the metal tube in the back of the air handpiece.
2. Insert the ridged end of a male quick connect hose mount Fitting (P/N 1259-0087) into the free end of the 54 inch (137cm) Air Hose.
3. Secure the Air Hose to the handpiece power cord with cable clips (P/N 1321-0085-01).

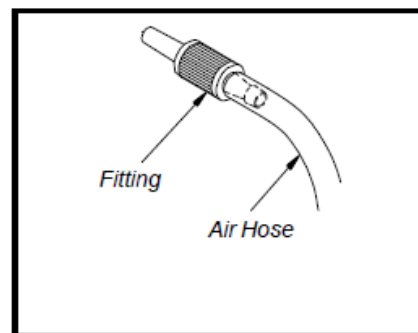

Figure 19. Air Hose To Fitting



TRADITIONAL METHOD CONT'D

4. Prepare a VisiFilter in the following manner.

- a) Connect a 1 inch (2.5cm) length of clear pvc Air Hose to each side of the VisiFilter; push and turn hose onto VisiFilter nipple to seat.
- b) To the free end of the Air Hose connected to the FLOW IN side of the VisiFilter, insert the ridged end of a female quick connect hose mount Fitting (P/N 1259-0086).
- c) Insert the ridged end of a male quick connect hose mount Fitting (P/N 1259-0087) in the free end of the Air Hose connected to the FLOW OUT side of the VisiFilter.

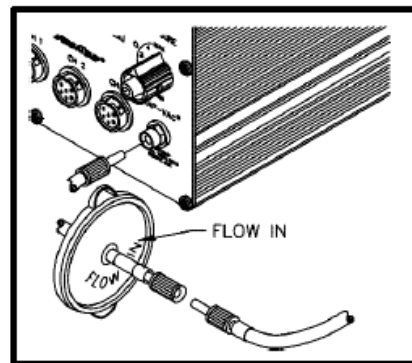

Figure 20. VisiFilter Preparation

- d) Connect VisiFilter Air Hose (with attached male quick connect hose mount Fitting) to the power source **SNAP-VAC** Port.
5. For vacuum, insert male quick connect hose mount Fitting connected to long Air Hose into female Fitting on 1 inch (2.5cm) Air Hose (connected to VisiFilter). For pressure, insert male quick connect hose mount fitting directly into the Controllable **PRESSURE** Port.

CAUTION

When removing any Air Hose, turn and pull. DO NOT attempt to pull hose directly off. Damage to or breakage of Vacuum Fitting or VisiFilter may occur.

6. Connect the handpiece power cord connector plug to one of the Power Receptacles. For convenience, PACE recommends the use of **CH 3** for air handpieces.

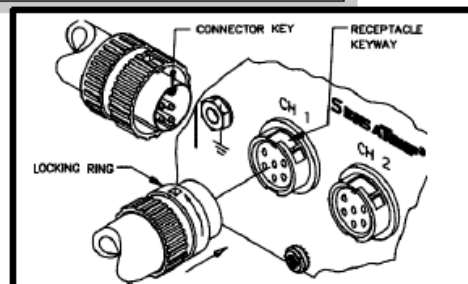

Figure 21. Handpiece Connection to TMC

NOTE

If more than one air-operated handpiece is connected to the **THERMAL MANAGEMENT CENTER**, insure that only one of the Air Hoses is connected to either the **SNAP-VAC** Port or Controllable **PRESSURE** Port. Attachment to both simultaneously will cause a deterioration in performance.

QUICK CONNECT METHOD

May be used with any SensaTemp handpiece except TJ-70 Mini ThermoJet.

1. Prepare a VisiFilter in the following manner.
 - a) Connect a 1 inch (2.5cm) length of clear pvc Air Hose to each side of the VisiFilter; push and turn hose onto VisiFilter nipple to seat.
 - b) To the free end of the Air Hose connected to the **FLOW IN** side of the VisiFilter, insert the ridged end of a female quick connect hose mount Fitting (P/N 1259-0086).
 - c) Insert the ridged end of a male quick connect hose mount Fitting (P/N 1259-0087) in the free end of the Air Hose connected to the **FLOW OUT** side of the VisiFilter.
2. Insert male quick connect hose mount Fitting (attached to VisiFilter assembly) into female **SNAP-VAC** Port on front panel of power source.

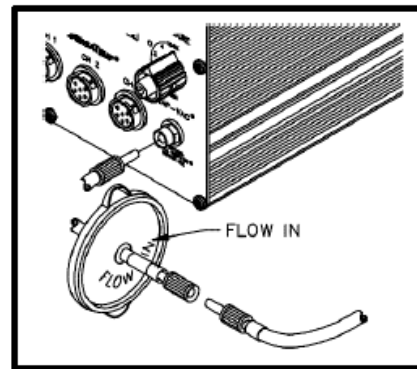

Figure 22. VisiFilter Preparation

QUICK CONNECT METHOD CONT'D

3. Attach the ridged end of a male quick connect hose mount Fitting (P/N 1259-0087) to each end of the 54 inch (137cm) Air Hose. Push and turn hose onto each Fitting to seat properly. You may install metal hose clamps (enclosed with system) to further secure connections.
4. For each air handpiece, attach ridged end of a female quick connect hose mount Fitting to a 1 inch (2.5cm) length of clear pvc Air Hose; push and turn hoses onto Fittings to seat properly. You may install a metal hose clamp (enclosed with system) to further secure the connection.

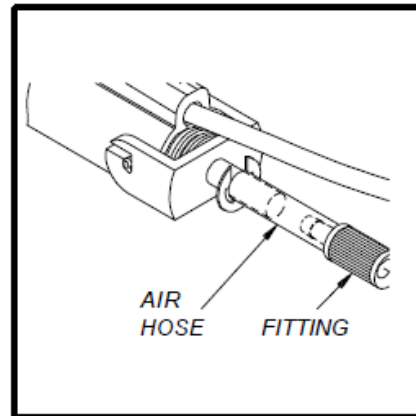

Figure 23. Air Hose To Handpiece

5. Attach the opposite end of the 1 inch (2.5cm) length of clear pvc Air Hose to the metal tube located at the rear of each handpiece.
6. Connect one end of the long Air Hose (with attached male quick connect hose mount Fitting) to the 1" (2.5cm) clear pvc Air Hose attached to the rear of the handpiece.
7. For vacuum, insert male quick connect hose mount Fitting attached to the remaining end of the long Air Hose into female quick connect hose mount Fitting on 1 inch (2.5cm) clear pvc Air Hose (connected to VisiFilter). For pressure, insert male quick connect hose mount fitting directly into the Controllable **PRESSURE** Port.
8. The long Air Hose may now be easily transferred between air handpieces by removal of male quick connect hose mount Fitting (attached to long Air Hose) from female quick connect hose mount Fitting at rear of air handpiece and attachment to another air handpiece.

CAUTION

When removing any Air Hose, turn and pull. DO NOT attempt to pull hose directly off. Damage to or breakage of vacuum fitting or VisiFilter may occur.

9. Connect the handpiece power cable plugs of each air handpiece to the Power Receptacles.



INTRODUCTION

The PRC 2000 systems are easy to operate and allow the operator the flexibility of using additional features as desired. The "Operation" portion of this manual will familiarize the user with the features of the system as received from the factory.

DEFINITIONS

Please read and become familiar with each of the following definitions. Each term is used repeatedly in the following operational procedures to avoid any possible confusion as to the intent of any particular instruction.

ACTIVE CHANNEL - Any channel with a connected handpiece.

AUTOMATIC POWER DOWN - Feature which turns off power to all three channels 90 minutes after all Active Channels have entered the Automatic Setback Mode.

AUTOMATIC TEMPERATURE SETBACK - System feature which, when enabled, will independently set back each channel's **SET TIP** Temperature to 180°C (350°F) after a user selected period of handpiece inactivity (10 to 90 minutes settable in 10 minute increments). This feature is enabled in the "CAL" Mode.

CALIBRATION (CAL) MODE - Mode of operation (indicated by "CAL" on the Digital Readout) in which the operator can quickly and easily recalibrate the system to insure accuracy and peak performance.

CURRENT CHANNEL - The channel whose temperature information may be set and displayed on the Digital Readout. The Current Channel is indicated by an illuminated LED next to its designation. The Auxiliary LED is illuminated in conjunction with the appropriate channel LED if an Auxiliary Channel is the Current Channel.

INACTIVE CHANNEL - Any channel without a connected handpiece.

SET TIP TEMPERATURE - Operator selected idle tip temperature entered into the system memory in Tip Set Mode for handpiece/tip combination connected to Current Channel.

TEMPERATURE DISPLAY MODE - Normal Operating Mode in which the true operating tip temperature of the handpiece/tip connected to the Current Channel is displayed on the Digital Readout.

TIP OFFSET CONSTANT - Specific value for a given handpiece/tip combination upon which the system automatically calculates the correct Tip Temperature Offset at the entered Set Tip Temperature.

TIP TEMPERATURE OFFSET - Temperature value difference between the point in the handpiece heater assembly at which temperature is sensed and the working end of the attached tip.

TIP OFFSET MODE - Mode of operation in which the Current Channel's **TIP OFFSET CONSTANT** value can be viewed or altered. In this mode, the **TIP OFFSET** LED flashes and the stored value appears on the Digital Readout.

TIP SET MODE - Mode of operation in which the Current Channel's Set Tip Temperature can be viewed or altered. In this mode, the **TIP SET** LED flashes and the stored value appears on the Digital Readout.

OPERATING TIP TEMPERATURE - The true tip temperature at which the handpiece tip operates at any given time. This temperature is displayed on the Digital Readout in Temperature Display Mode

THERMAL MANAGEMENT CENTER

POWER UP

1. Insure that the system is properly prepared for operation. Refer to the "Set-Up" portion of this manual. The handpieces selected for your application should be connected to the unit. Connect any single air hose to either the **SNAP-VAC** Port or Controllable **PRESSURE** Port. Never connect air hoses to both ports simultaneously. Always leave VisiFilter connected to **SNAP-VAC** Port.

2. Turn the **POWER** Switch ON ("1").

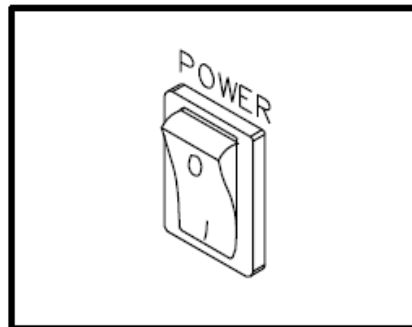

Figure 24. Power On

3. On power up, the Digital Readout will display "888" initially; change to "1 - 3" (this number may be different on your system) and then display normal temperature information (Temperature Display Mode).

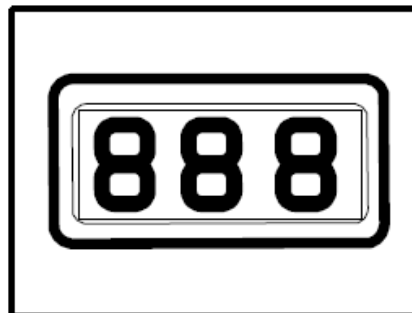

Figure 25. Digital Readout "888"

OPERATION

CHANNEL LED OPERATION

- The Channel LED (**CH 1**, **CH 2** or **CH 3**) of the first Active Channel encountered by the system (Channel with connected handpiece) will be illuminated. This is the Current Channel. The Auxiliary LED (in conjunction with the appropriate Channel led (**CH 1**, **CH 2** or **CH 3**) will illuminate if a Current Channel is an Auxiliary Channel (**AUX 1**, **AUX 2** or **AUX 3**). If no Channels are active (no handpiece connected), only the **CH 1** LED will be illuminated and "E - 1" will be displayed on the Digital Readout.

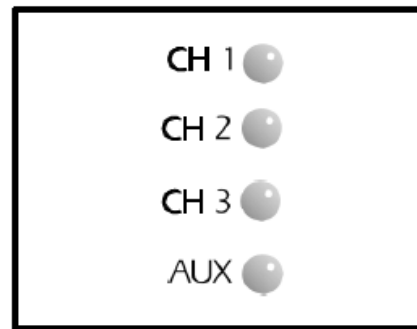

Figure 26. Channel LEDs

- Disconnect the handpiece from the Power Receptacle associated with the Current Channel (e.g., if **CH 1** LED is illuminated, disconnect the handpiece connected to **CH 1**). The unit will now select the next Active Channel encountered as the Current Channel and illuminate the corresponding LED.

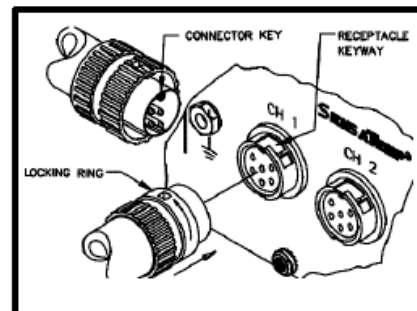

Figure 27. Handpiece Connection, TMC

- Reconnect the handpiece removed in step #5.



DIGITAL READOUT OPERATION

- The Digital Readout provides a 3 digit display of the Current Channel temperature information. The Digital Readout will show the Set Tip Temperature in the **TIP SET** Mode, Tip Offset Constants in **TIP OFFSET** Mode and the True (Operating Tip) Temperature in the Temperature Display Mode (normal operation).

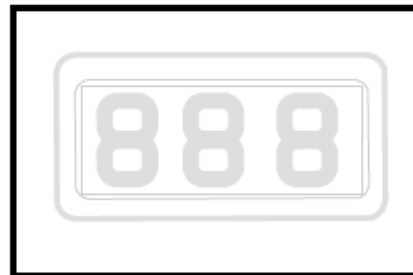

Figure 28. Digital Readout "888"

PANEL CONTROLS

- With three handpieces connected to the system (no auxiliary accessories connected), press the **CH SELECT** Key several times to observe the lighting of the **CH 1**, **CH 2** & **CH 3** LEDs. Each subsequent pressing will turn an LED off and turn the next Active Channels' LED on. The illumination sequence will be **CH 1** to **CH 2** to **CH 3** and then back to **CH 1**. Unplug any one of the handpieces and repeat. The LED of any Inactive Channel (no attached handpiece) will not light. The next Active Channel in sequence will light. NOTE: **CH 1** LED will illuminate and "**E-1**" will be displayed on the Digital Readout if there are no Active Channels. If all channels were set to "OFF", the Digital Readout will display "OFF".

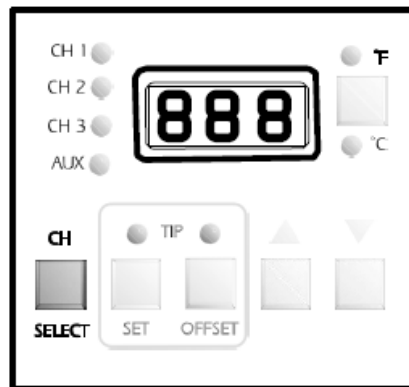

Figure 29. TMC Front Panel

- Press the **TIP OFFSET** Key. The **TIP OFFSET** LED will blink and the Digital Readout will display the **TIP OFFSET CONSTANT** for the Current Channel. As received from the factory, the Digital Readout will display "3" FOR °C ("6" FOR °F). If the **TIP OFFSET** Key is immediately pressed again, or if no other operation occurs within 5 seconds, the LED will turn off and the Digital Readout will revert to the Temperature Display Mode (normal operation).

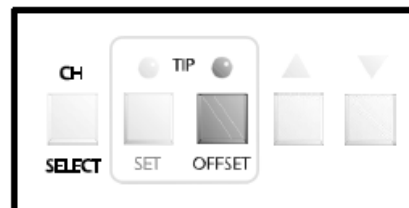

Figure 30. Tip Offset Key Activation



NOTE

Refer to "Tip & Temperature Selection" for a complete discussion of Tip Temperature Offset function.

- Press the **TIP OFFSET** Key once to enter **TIP OFFSET Mode**. Immediately press and hold the Scroll Up Key. Observe the displayed **TIP OFFSET CONSTANT** increase, first in 1° and then in 10° increments. Release the Scroll Up Key when the Digital Readout reads "33" for °C ("60" for °F).

NOTE

If the Digital Readout displays "P --", a password has been previously installed. Enter the password at this point to continue. Refer to the "Password" portion of this manual for details on password operation.

- While still in the **TIP OFFSET Mode** (**TIP OFFSET LED** flashing) press and hold the Scroll Down Key. Observe the displayed **TIP OFFSET CONSTANT** decrease first in 1° and then in 10° increments. Release the key when the Digital Readout displays "28" for °C ("50" for °F).

- Immediately press the **TIP OFFSET** Key to exit the **TIP OFFSET Mode** and enter the new **TIP OFFSET CONSTANT** for the Current Channel into the system memory. Notice that the **TIP OFFSET LED** remains illuminated (not flashing). **ONLY IF A CURRENT CHANNEL HAS A TIP OFFSET CONSTANT GREATER THAN THE DEFAULT ("3" for °C or "6" for °F) DOES THIS LED REMAIN ILLUMINATED.** The system will retain stored Set Tip Temperatures and **TIP OFFSET CONSTANTS** even when power is removed.

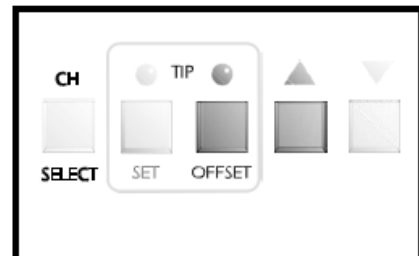

Figure 31. Increase Tip Offset Value

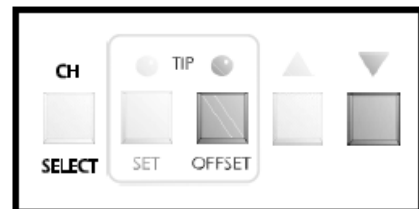

Figure 32. Decrease Tip Offset Value

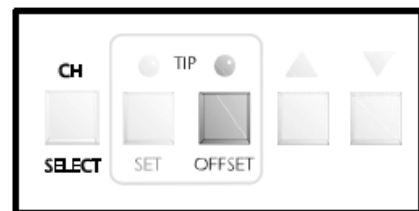

Figure 33. Store Tip Offset Value



PANEL CONTROLS CONT'D

13. Press the **TIP SET** Key once. This is **TIP SET** Mode. The **TIP SET** LED will flash and the Digital Readout will display the stored Set Tip Temperature for the Current Channel. As received from the factory, the Digital Readout will display "OFF". Also, if no other operation occurs within 6 seconds, the LED will turn off and the Digital Readout will revert to the Temperature Display Mode. Pressing the **TIP SET** Key a second time will immediately place the system in the Temperature Display Mode (normal operation).

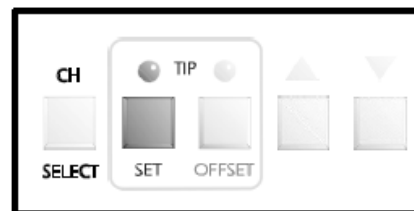

Figure 34. Display Stored Tip Temp.

14. Plug an auxiliary accessory (if purchased) into any of the three Aux Power Receptacles (**AUX 1**, **2** or **3**). Repeat step #8.

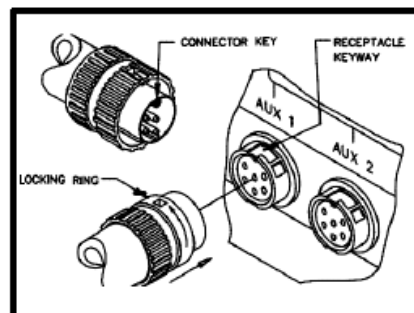

Figure 35. Aux. Accessory Connection

Notice that each subsequent pressing of the **CH SELECT** Key will illuminate the **AUX** LED and the Channel LED corresponding to the auxiliary channel to which the auxiliary accessory is connected. The sequence in this case would be **CH 1** to **CH 2** to **CH 3** to **CH 1** (plus the Auxiliary LED) to indicate the active Auxiliary Channel (**AUX 1**) and then back to **CH 1**.

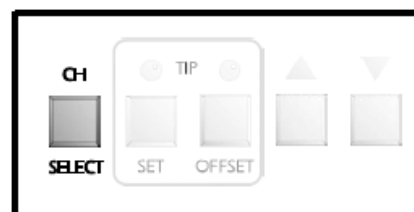

Figure 36. Changing Current Channel

15. Press the **TIP SET Key** once again to enter the **TIP SET Mode**. Press and hold the Scroll Up Key. Observe as the displayed Set Tip Temperature increases first in 1°, then in 10° increments (°C or °F). Release the key when the Digital Readout reads 371°C (or 700°F). Immediately press the **TIP SET Key** once again. Observe the Digital Readout as the Operating Tip Temperature reaches 371°C (or 700°F).

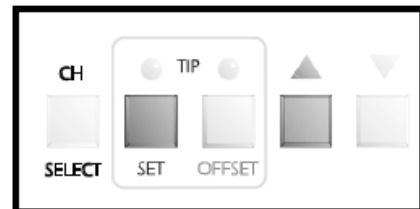

Figure 37. Enter Tip Temp. Set Mode

16. Press the °F/°C Key several times to observe the alternating illumination of the °F & °C LEDs. Each subsequent pressing of the key will turn one LED on and the other off. Also notice as the Digital Readout changes to display the Operating Tip Temperature in °F when the °F LED is illuminated and in °C when the °C LED is illuminated.

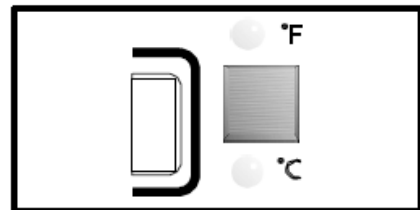

Figure 38. °F To °C Digital Readout

17. Press the **TIP SET Key** once to enter the **TIP TEMPERATURE SET Mode**. Immediately press & hold the Scroll Down Key. Observe as the displayed **TIP SET Temperature** decreases first in 1° and then in 10° increments (°C or °F). Release the key when the Digital Readout displays 343°C (650°F). Immediately press the **TIP SET Key** once again (or wait 6 seconds) and observe the Operating Tip Temperature decrease to 343°C (650°F).

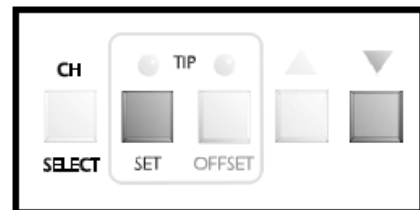

Figure 39. Decreasing Set Tip Temp.



PANEL CONTROLS CONT'D

18. Press the **TIP SET** Key once again and use the Scroll Up and Scroll Down Keys to enter your desired Set Tip Temperature. Immediately press the **TIP SET** Key to exit the **TIP SET** Mode. This enters the new Set Tip Temperature for the Current Channel into system memory.

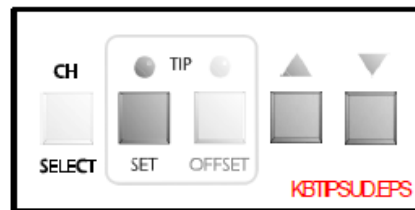

Figure 40. Changing Set Tip Temperature

NOTE

If a Password has been installed in the system, press the °F/°C Key to reactivate Password protection.

19. Note the Current Channel displayed on the system. Turn the **POWER** Switch to the OFF ("0") position. Turn the **POWER** Switch back to the ON ("1") position. Using the **CH SELECT** Key, select the channel displayed in step #18. Notice that the **TIP OFFSET** LED is illuminated to indicate that a **TIP OFFSET CONSTANT** higher than the default ("3" for °C or "6" for °F) has been stored in system memory.

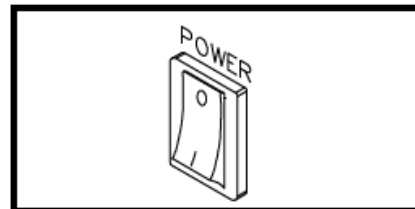

Figure 41. Power Off

20. Press the **TIP OFFSET** Key. Notice that the system has retained the stored **TIP OFFSET CONSTANT**. Press the key once again to exit **TIP OFFSET** Mode.

Figure 42. Storing Tip Offset Value



21. Press the **TIP SET** Key. Notice that the system has retained the stored Set Tip Temperature in memory. Immediately press the **TIP SET** Key once again to exit **TIP SET** Mode.

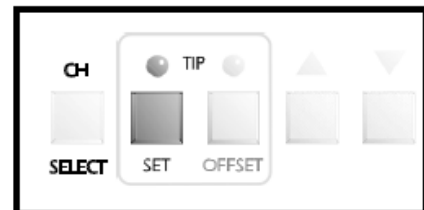

Figure 43. Store Set Tip Temperature

22. In order to prevent a handpiece/tip combination from inadvertently operating at an incorrect Tip Temperature, a safety feature incorporated within the system will prevent retention of a stored TIP OFFSET CONSTANT if a handpiece is disconnected. The TIP OFFSET CONSTANT will return to the default value of "3" for °C ("6" for °F). Disconnect the handpiece connected to the Current Channel. Reconnect the handpiece to the same channel. Notice that the Current Channel changes to the next Active Channel.

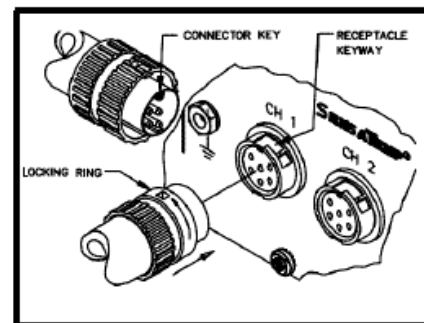

Figure 44. Handpiece Connection , TMC

23. Press the **CH SELECT** Key, as necessary, to change the Current Channel to the channel disconnected in step #22.

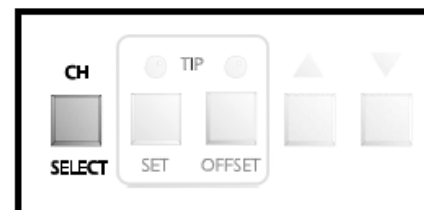

Figure 45. Changing Current Channel



PANEL CONTROLS CONT'D

24. Press the **TIP OFFSET** Key. Notice that the **TIP OFFSET CONSTANT** has now changed to the default value of "3" for °C ("6" for °F) and the **TIP OFFSET LED** turns off. Whenever a channel becomes inactive, the system memory automatically reverts to the default **TIP OFFSET CONSTANT**.

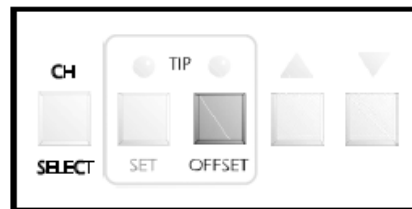

Figure 46. Tip Offset Default

25. While in **TIP OFFSET Mode** (**TIP OFFSET LED** flashing), use the Scroll Up and Scroll Down Keys to set a desired **TIP OFFSET CONSTANT**. Press and release the **TIP OFFSET** Key to exit **TIP OFFSET Mode** to store **TIP OFFSET CONSTANT** in system memory.

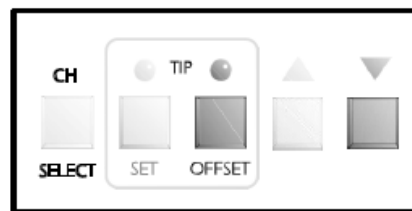

Figure 47. Adjust Tip Offset Value



26. Using the **CH SELECT** Key, select each Active Channel in sequence, making it the Current Channel (temperature information displayed on Digital Readout). Using the procedures described in previous steps #10 thru 18 and steps #24 thru 25 as a reference, enter and store desired **SET TIP** Temperatures and appropriate **TIP OFFSET** CONSTANTS into system memory. Refer to the "Tip & Temperature Selection System" charts sent with your unit and the "Tip & Temperature Selection" portion of this manual for more detailed information on selection of the proper Tip, Handpiece and Temperature Options for your particular application.

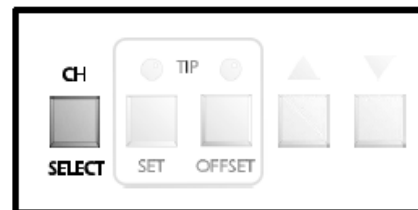

Figure 48. Change Current Channel

NOTE

The PRC 2000 systems incorporate a "Dynamic Offset" feature which automatically adjusts the Tip Temperature Offset (based on the entered TIP OFFSET CONSTANT) for any Set Tip Temperature established by the operator. This ensures the maintenance of true, accurate Tip Temperatures. Simply stated, any operating Tip Temperature displayed on the Digital Readout will be correct.

Always set the appropriate TIP OFFSET CONSTANT for the selected Handpiece/Tip combination (listed in the shaded area on the Tip & Temperature Selection System Charts) before entering the desired Set Tip Temperature. The Set Tip Temperature + the Dynamically Adjusted Tip Temperature Offset value (usually different from the entered Tip Offset Constant) cannot exceed 489°C (912°F). If this limit is exceeded, the system will automatically lower the maximum possible Set (and Operating) Tip Temperature accordingly.



TIP & TEMPERATURE SELECTION

With any heating system, actual tip temperatures can differ greatly from temperature control settings. PACE's unique "Tip & Temperature Selection System" allows you to select and maintain True Tip Temperatures for any size and type of tip and handpiece using the appropriate TIP OFFSET CONSTANT. Included with your system is a Chart Holder which holds Procedural Instructions, a Quick Reference Guide, a Customer Log and Charts for each handpiece currently available from PACE. Follow the procedure given in the chart marked "Introduction" when using the charts for any particular handpiece. Listed below is the summarized procedure.

PROCEDURE

Select the appropriate Handpiece Chart for your application based on component type and/or procedure (e.g., SMD removal, thru-hole soldering, etc.) and identify the correct tip. Install tip into handpiece and follow the procedure below.

1. In **Tip Temperature Offset (TIP OFFSET)** Mode, enter the TIP OFFSET CONSTANT (# in shaded area) corresponding to your selected tip for the channel powering the handpiece.
2. In **Tip Temperature Set (TIP SET)** Mode, set **ANY** desired Tip Temperature up to the maximum. The tip will idle at this temperature.

NOTE

The Tip Offset Value is internally calculated and adjusted automatically (based on the TIP OFFSET CONSTANT) so that a True Tip Temperature is always displayed on the Digital Readout - even when the desired Set Tip Temperature is changed.



PASSWORD

A password feature of the **THERMAL MANAGEMENT CENTER** which, when activated, will prevent unauthorized alteration of stored System and Channel features listed in Table 1 "Factory Settings". If a password has been installed, "P --" will appear on the Digital Readout to prevent the operator from changing any of the stored settings. Entry of the correct password at this point will allow the operator to proceed with desired changes. Listed following are procedures for all password entry, change and removal operations.

INITIAL INSTALLATION OF A PASSWORD

1. Place the **POWER** Switch in the OFF ("0") position.

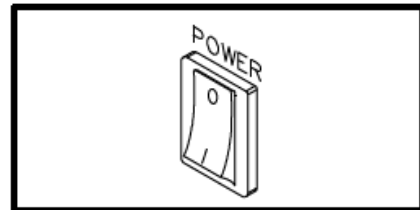

Figure 49. Power Off

2. Press and hold the **TIP SET** and the °F/°C Keys down.

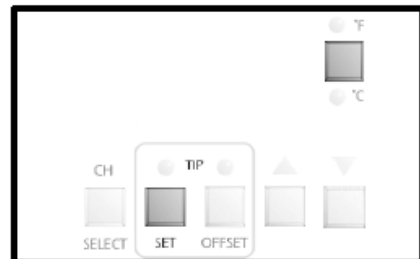

Figure 50. Enter Password Mode

3. Place **POWER** Switch in the ON ("1") position. All the **THERMAL MANAGEMENT CENTER** LEDs will illuminate. The Digital Readout will read "888" and change to read "1 - 0". This number may be different on your unit.



Figure 51. Digital Readout "888"



INITIAL INSTALLATION OF A PASSWORD CONT'D

4. Release the **TIP SET** and the °F/°C Keys. The system is now in Password Mode. The Digital Readout will display "PS-" and only the three Channel LEDs plus the Auxiliary LED will remain illuminated signifying that the system does not have a Password installed. NOTE: If "P - -" is displayed on the Digital Readout instead of "PS-", a Password has been previously installed. Refer to the "Removing/Changing Password" section procedure.

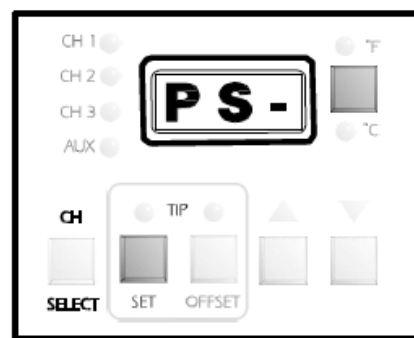

Figure 52. Password Status

5. Write down the Password desired. Note that the **TIP SET** Key may never be the first key of a Password (see step #6).

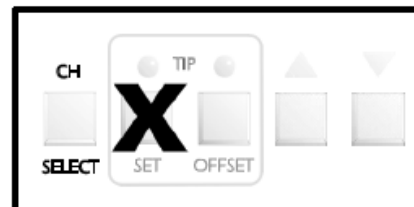

Figure 53. First Key Not Tip Set Key



6. Press any key except the **TIP SET** Key as the first key of the Password.

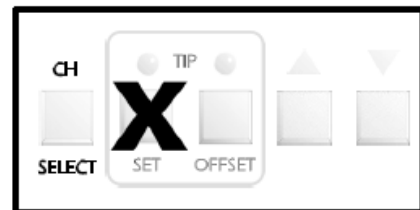

Figure 54. First Key Not Tip Set Key

7. Press any key as the second key of the Password.

8. Press any key as the third (and last) key of the Password.

The Calibration Mode has been automatically entered and the Digital Readout will now display "CAL". If no calibration parameters need to be changed, exit Calibration Mode and go to regular operation by pressing the **TIP OFFSET** Key. Otherwise, perform calibration now (refer to the CALIBRATION/SYSTEM SETUP section). When finished doing calibration, press the **TIP OFFSET** Key to leave "CAL" Mode and enter Temperature Display Mode (normal operation).



Figure 55. Cal Mode

NOTE

The Password is not permanently stored until the Calibration Mode ("CAL") is exited normally by pressing the **TIP OFFSET** Key. If the **POWER** Switch is turned OFF ("0") while still in the Calibration Mode, the Password will not be saved.



REMOVING A PASSWORD

1. Place the **POWER** Switch in the OFF ("0") position.

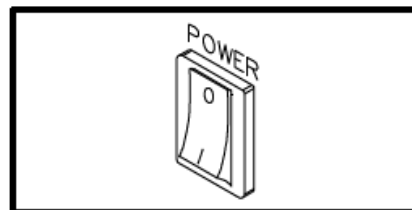

Figure 56. Power Off

2. Press and hold the **TIP SET** and the °F/°C Keys down.

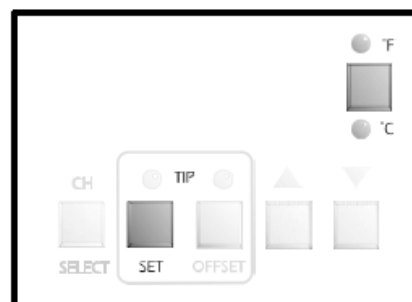

Figure 57. Enter Password Mode

3. Place **POWER** Switch in the ON ("1") position. All the **THERMAL MANAGEMENT CENTER** LEDs will illuminate. The Digital Readout will read "888" and change to read "1 - 0". This number may be different on your unit.



Figure 58. Digital Readout "888"



4. Release the **TIP SET** and the **°F/°C** Keys. The Digital Readout will now display "P - -" signifying that the system is now asking for the operator to enter the Password previously installed into the system's memory.

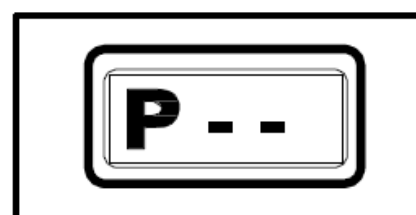

Figure 59. Stored Password

NOTE

If "PS-" is displayed on the Digital Readout instead of "P - -", a Password has not been previously installed. Refer to the "INSTALLING A PASSWORD" section of this manual.

5. Press the first key of the Password.
6. Press the second key of the Password.

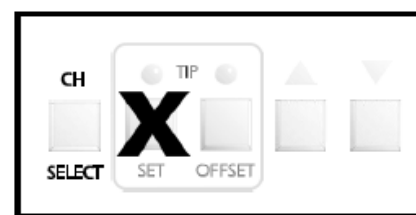

Figure 60. First Key Not Tip Set Key



REMOVING A PASSWORD CONT'D

7. Press the third (and last) key of the Password. The Digital Readout will now display "PS-".



Figure 61. Digital Readout "P S -"

8. Press the **TIP SET** Key.

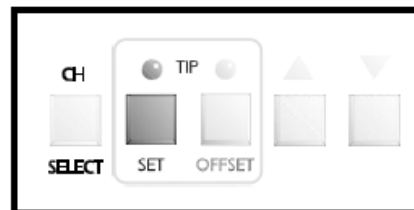

Figure 62. Press Tip Set Key

9. The Calibration Mode has been automatically entered and the Digital Readout will now display "CAL". If no calibration parameters need to be changed, exit Calibration Mode and enter Temperature Display Mode (normal operation) by pressing the **TIP OFFSET** Key. Otherwise, perform calibration now (refer to the CALIBRATION/SYSTEM SETUP section). When finished with calibration, press the **TIP OFFSET** Key.



Figure 63. Digital Readout "CAL"



NOTE

The password is not permanently removed until the Calibration Mode is exited normally by pressing the **TIP OFFSET** Key. If AC POWER is turned off while still in the Calibration Mode, the password will not be removed.

CHANGING THE PASSWORD

1. Place the **POWER** Switch in the OFF ("0") position.

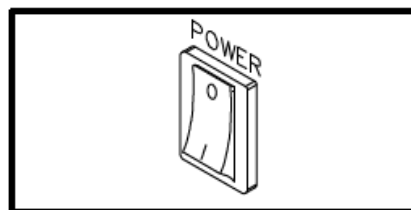

Figure 64. Power Off

2. Press and hold the **TIP SET** and the °F/°C Keys down.

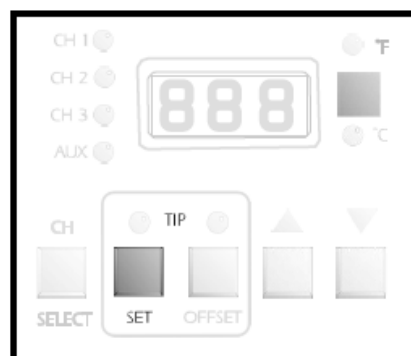

Figure 65. Password Mode Entry



CHANGING THE PASSWORD CONT'D

3. Place **Power** Switch in the ON ("1") position. All the **THERMAL MANAGEMENT CENTER** LEDs will illuminate. The Digital Readout will read "888" and change to read "1-0". This number may be different on your unit.

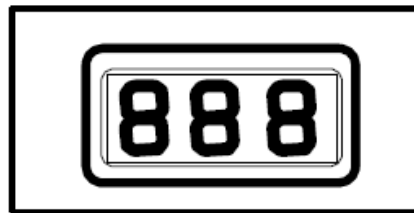

Figure 66. Digital Readout "888"

4. Release the **TIP SET** and the °F/°C Keys. The Digital Readout will now display "P - -" signifying that the system has a Password installed. NOTE: If "PS-" is displayed on the Digital Readout instead of "P - -", a Password has not been previously installed. Refer to the "INSTALLING A PASSWORD" procedure.

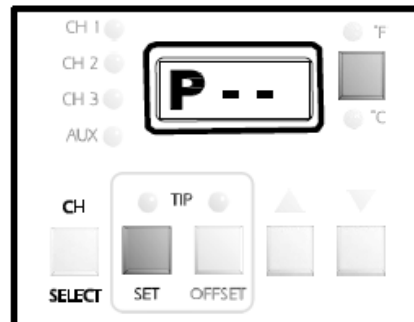

Figure 67. Digital Readout "P - -"

5. Write down the new Password desired. Remember that the **TIP SET** Key may never be the first key of a password.

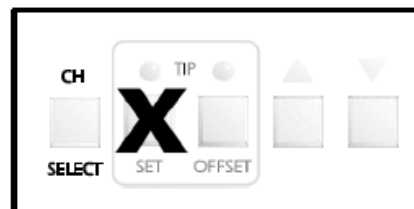

Figure 68. First Key Not Tip Set Key



6. Press the first key of the old Password.
7. Press the second key of the old Password.
8. Press the third (and last) key of the old Password.

9. The Digital Readout will now display "PS-".



Figure 69. Digital Readout "P S -"

10. Press any key, except the **TIP SET** Key, as the first key of the new Password.

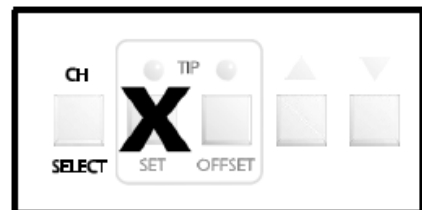

Figure 70. First Key Not Tip Set Key

CHANGING THE PASSWORD CONT'D

11. Press any key as the second key of the new Password.
12. Press any key as the third (and last) key of the new Password.
13. The Calibration Mode has been automatically entered and the Digital Readout will now display "CAL". If no calibration parameters need to be changed, exit Calibration Mode and go to Temperature Display Mode (normal operation) by pressing the **TIP OFFSET** Key. Otherwise, perform calibration now (refer to the CALIBRATION/SYSTEM SETUP section). When finished with calibration, press the **TIP OFFSET** Key.

NOTE

The Password is not permanently replaced until the Calibration Mode is exited normally by pressing the **TIP OFFSET** Key. If AC POWER is turned off while still in the Calibration Mode, the new Password will not be saved.



Figure 71. Digital Readout "CAL"

CLEARING A LOST PASSWORD

1. Place the **POWER** Switch in the OFF ("0") position and disconnect the AC power cord from the system.

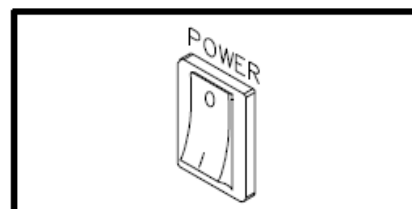

Figure 72. Power Off

DANGER

POTENTIAL SHOCK HAZARD
The following steps are to be performed by **qualified service personnel only**. Removal of the rear panel exposes line voltage parts. Service personnel must insure that AC power cord is disconnected when installing jumper wire (step #5) and disconnecting jumper wire (step #9).

2. Remove the 12 screws securing the Rear Panel to the system chassis.
3. Lay the Rear Panel on the work surface exposing the inside of the system.
4. Locate the 2 Pin Header inside the power source chassis near the rear and center.
5. Place a jumper wire across the pins.
6. Install the AC power cord. Place the **POWER** Switch in the ON ("1") position. The system is now in Calibration ("CAL") Mode.
7. Press the **TIP OFFSET** Key to exit Calibration ("CAL") Mode. After a few seconds, any password will be removed.
8. Place the **POWER** Switch in the OFF ("0") position. Disconnect the AC power cord.
9. Remove the jumper wire.
10. Replace the rear panel cover using the screws removed in step #2. Install the AC power cord.

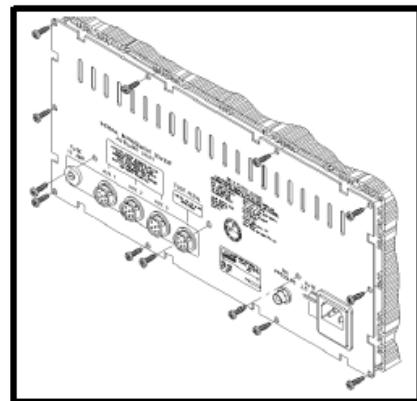

Figure 73. Rear Panel Removal

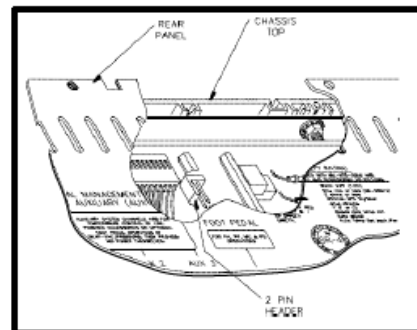

Figure 74. 2 Pin Header

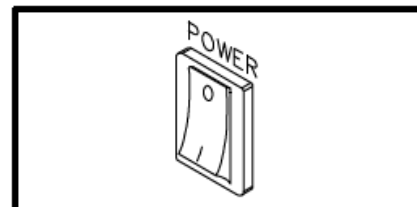

Figure 75. Power Off



CALIBRATION

INTRODUCTION

In Calibration (CAL) Mode, you can:

1. Change the Upper & Lower Temperature limits for each channel independently.
2. Set the default temperature scale to °F or °C as desired.
3. Enable or disable the Auto Temperature Setback/Power Down features.

PROCEDURE

1. Place **POWER** Switch in the "Off" ("0") position.

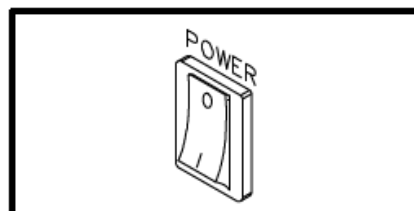

Figure 76. Power Off

2. Press and hold the **TIP SET** and Scroll Down Keys.

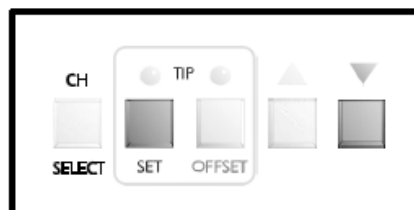

Figure 77. Calibration Entry



3. Place **POWER** Switch in the On ("1") position. All of the system LEDs will light. The Digital Readout will read "888" and change to read "1-0". This number may be different on your unit.

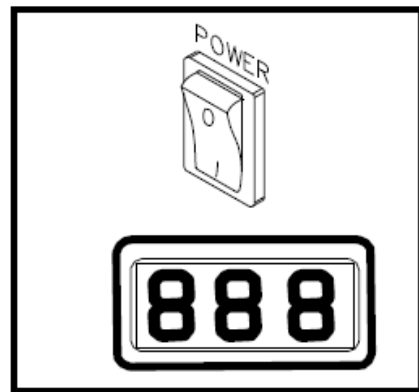

Figure 78. Digital Readout "888"

4. Release the **TIP SET** and Scroll Down Keys. The Digital Readout will now display "CAL" and only the three Channel LEDs will remain lit signifying that the system is now in Calibration (CAL) Mode. NOTE: If a password has been installed, "P - -" will appear on the Digital Readout. Enter the password key sequence to display "CAL".



Figure 79. Digital Readout "CAL"



°F/°C READOUT DEFAULT

5. Press and release the **TIP SET** Key. The Digital Readout will display "S - X" (X = "-" or 1-9). Either the °F or °C LED will be on. This is the default temperature scale of the Digital Readout (e.g., if the °C LED is on, the Digital Readout will display Tip Temperatures and Tip Offset values in °C).

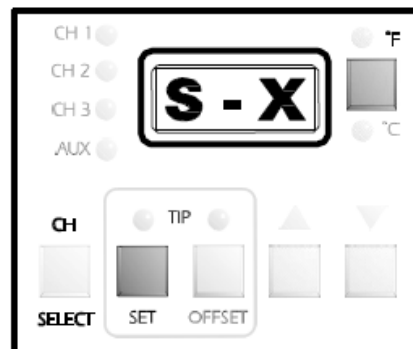

Figure 80. Digital Readout "S - X"

6. Press and release the °F/°C Key to change the default. Each subsequent press and release of the key will change the default.

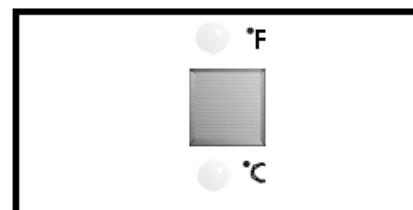

Figure 81. Change Temperature Default

AUTOMATIC TEMPERATURE SETBACK

7. As received from the factory, "S - -" will be displayed indicating that the Automatic Temperature Setback is turned off. A "1" thru "9" appearing on the right side of the Digital Readout indicates time to Automatic Setback in increments of 10 minutes. For example, "S-3" would indicate that any Active Channel will set back its handpieces' Set Tip Temperature to 180°C (350°F) after 30 minutes of handpiece inactivity (non-use). To change the time period or turn the Automatic Temperature Setback feature off or on, use the Scroll Keys. Press the Scroll Up Key to increase the time period and/or enable the feature. Press the Scroll Down Key to decrease the time period or disable the feature.

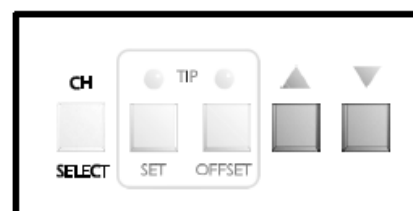

Figure 82. Adjust Setback Time

- Press the **TIP SET** Key to store the °F/°C default and Automatic Temperature Setback time value in system memory. The Digital Readout will revert to "CAL" and only the **CH 1** LED will remain lit.

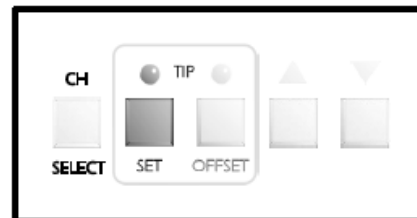

Figure 83. Store Temperature Default

AUTOMATIC POWER DOWN

- The Automatic Power Down feature is enabled when any time period (10 - 90 minutes) for Automatic Temperature Setback is entered in step #7. If no time period is selected (i.e., "S - -" appears on the Digital Readout), the Automatic Power Down feature is disabled. No additional steps are necessary. The Automatic Power Down feature operates when (and only when) all channels are in Temperature Setback. For example, power to all channels is turned off 90 minutes after the last Active Channel's Tip Temperature is set back.

CHANNEL SECTION

- The **CH 1** LED is now on signifying that Channel 1 is ready to set temperature limits. Perform steps 11 through 17 to calibrate. Change channels as directed and repeat these steps for each channel.



TEMPERATURE LIMITS

NOTE
All temperature limits are entered and stored in system memory in degrees F.

LOWERTEMPERATURELIMIT

- Press and release the **TIP SET** Key. The Digital Readout will now display "L-X" (X = 1-9). This is the stored value of the Lower Temperature Limit in increments of 100°F. For example, "L-5" is displayed indicating a lower temperature limit of 500°F.

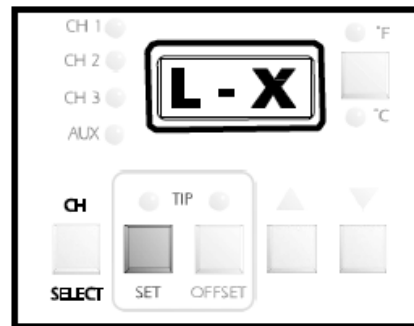

Figure 84. Digital Readout "L - X"

- Press Scroll Keys as necessary to increase (Scroll Up Key) or decrease (Scroll Down Key) the Lower Temperature Limit.

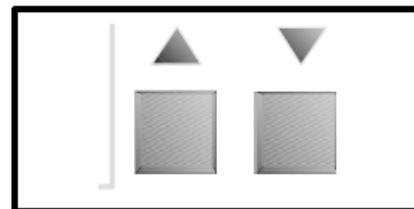

Figure 85. Change Lower Temp. Limit

- Press and release the **TIP SET** Key.

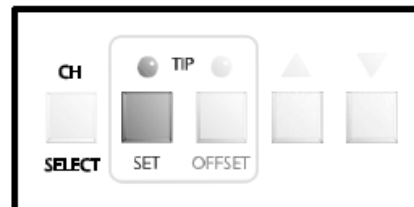

Figure 86. Press Tip Set Key

UPPER TEMPERATURE LIMIT

- The Digital Readout now displays "H-X" (X = 1-9). This is the stored value of the upper temperature limit in increments of 100°F.

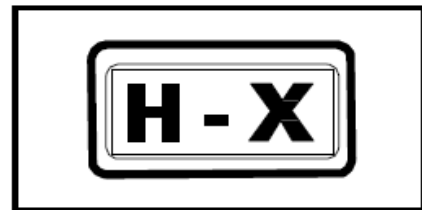

Figure 87. Digital Readout "H - X"

- Press Scroll Keys as necessary to increase (Scroll Up Key) or decrease (Scroll Down Key) the upper temperature limit.

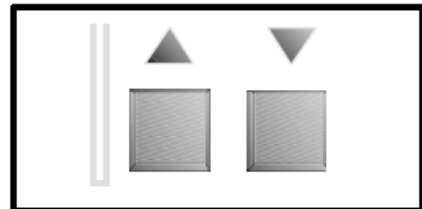

Figure 88. Change Upper Temp. Limit

- Press and release the **TIP SET** Key. The Digital Readout will now display "CAL". The next Active Channel now becomes the Current Channel. Perform steps 11 through 16 to set upper and lower temperature limits for the other channels (**CH 1**, **CH 2**, **CH 3**, **AUX 1**, **AUX 2** and **AUX 3**). After all channels have been calibrated, you may exit the Calibration (CAL) Mode by pressing and releasing the **TIP OFFSET** Key.

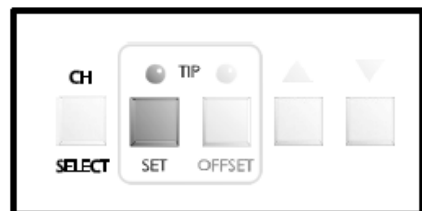

Figure 89. Press Tip Set Key

UPPER TEMPERATURE LIMIT CONT'D

17. All values, features and defaults entered during the calibration are now stored in memory and all Set Tip Temperatures are turned "OFF". All Channel TIP OFFSET CONSTANTS are set to the default value of "3" for °C ("6" for °F).

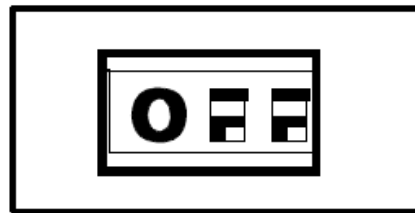

Figure 90. Digital Readout "OFF"

TEMPERATURE SETBACK

The PRC 2000 system is equipped with a Temperature Setback feature which, when enabled, will preserve tip life and reduce energy consumption.

ACTIVATION

There are two ways in which the system will enable the Temperature Setback feature.

1. **AUTOMATIC OPERATION** - The system memory can be programmed so that each Active Channel will automatically and independently set back its Set Tip Temperature to 180°C (350°F) after a selected period (10-90 minutes) of handpiece inactivity. See "Calibration" section for details on programming this feature.
2. **MANUAL OPERATION** - The operator can manually force the system to place all Active Channels in Temperature Setback by performing the following procedure.

- a) Press and hold the Scroll Down Key.

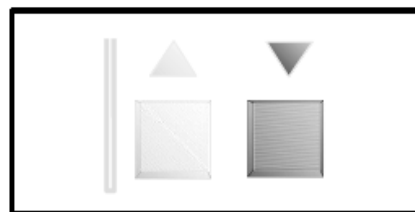

Figure 91. Forcing Temp. Setback



- b) Press the Scroll Up Key.
- c) Release both keys.

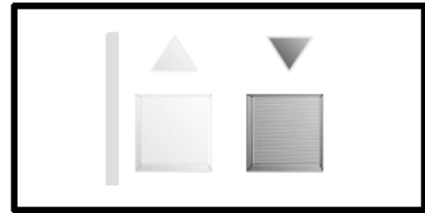

Figure 92. Temp. Setback Entry

OPERATION

1. Temperature Setback for each channel is indicated by the following.
 - a) The Current Channel LED will flash off once each 2 second period when that channel is in Temperature Setback Mode.
 - b) Any Active, non-Current Channel LED will flash on once each 2 second period when that channel is in Automatic Temperature Setback Mode.
2. Any Inactive Channel will not enter Temperature Setback Mode.
3. Any Active Channel whose Set Tip Temperature is less than 180°C (350°F) will enter Temperature Setback Mode but will remain at its original Set Tip Temperature.

EXITING AUTOMATIC TEMPERATURE SETBACK MODE



Listed below are 4 different ways to exit Temperature Setback Mode.

1. For any individual channel, perform the following operation.

- a) Press and release the **CH SELECT** Key until the Setback Channel becomes the Current Channel shown on the Digital Readout.

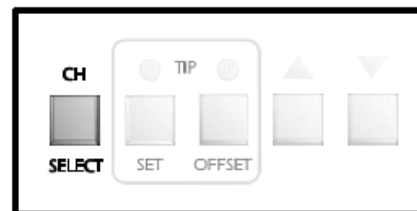

Figure 93. Changing Channel

- b) Press and release the Scroll Up Key.

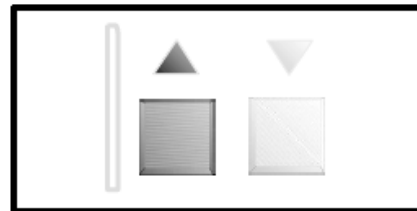

Figure 94. Restore Previous Tip Temp.

- c) The system will now restore the previous Set Tip Temperature of the Current Channel.
- d) Observe the Digital Readout as the Operating Tip Temperature increases to the Set Tip Temperature (if above 180°C (350°F)). For optimum performance, **DO NOT** attempt to use the attached handpiece until Set Temperature is achieved.

2. For any individual channel, the attached handpiece may be disconnected and reconnected. The previously stored Set Tip Temperature will be restored as in method #1 but the Tip Temperature Offset value

will change to the default value of "3" for °C ("6" for °F).

To exit Temperature Setback Mode for all Channels, do either of the following.

3. Press and hold the Scroll Down Key; press the Scroll Up Key. Release both keys. This is the preferred method.

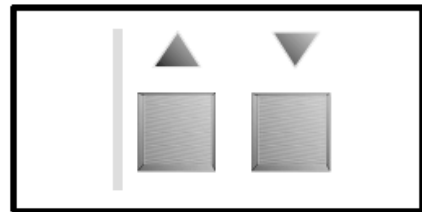

Figure 95. Exit Setback Mode

4. Method "3" is preferred but you can turn the **POWER** Switch "OFF" (0) and then back "ON" (1). Set Tip Temperature and TIP OFFSET CONSTANTS will be simultaneously restored on all channels.

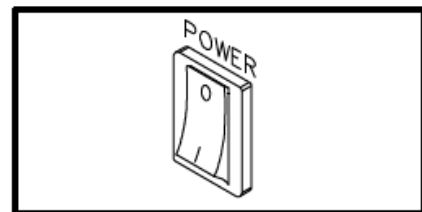

Figure 96. Power Off

FACTORY DEFAULT

As received from the factory, the system will not go into Automatic Temperature Setback. To enable this feature, refer to the "Calibration" portion of this manual.



AUTOMATIC POWER DOWN

The Automatic Power Down feature of the PRC 2000 system is a safety feature which removes power from all channels 90 minutes after all Active Channels have entered the Temperature Setback Mode. This feature is not programmable and is automatically enabled when all Active Channels are in the Temperature Setback Mode.

OPERATION

When all Active Channels have entered Automatic Temperature Setback Mode, a 90 minute timer within the system circuitry will start running.

1. If the system has no Active Channels (no connected handpieces), Automatic Shutdown will not occur.
2. If any key is pressed during the 90 minute time period, the timer is reset. Timer will not start timing out again until all Active Channels are in Temperature Setback Mode.
3. During the last minute before the 90 minutes expire, an audible tone will occur every 4 seconds to alert the operator.
4. At the end of the 90 minute period, the system will enter the Power Down Mode. Power is removed from all channels, all Channel LEDs will stop flashing and the Digital Readout will display a flashing "OFF".

EXITING POWER DOWN MODE

Power Down can be exited with all channels returning to normal operation by pressing any key or by turning the **POWER** Switch OFF ("0") and then back ON ("1").

DIGITAL READOUT MESSAGE CODES

Listed below are message codes and a description of each which may be displayed on the Digital Readout during the Calibration procedure.

DISPLAY MESSAGE	DESCRIPTION
E-1,E-2,E-3 OR E-4	Refer to "CORRECTIVE MAINTENANCE" section.
CAL	Indicates that system is in the Calibration Mode.
H-X	Ready to accept new Upper Temperature Limit setpoint for this channel, where: X is limit in hundreds of degrees F.
L-X	Ready to accept new Lower Temperature Limit setpoint for this channel, where: X is limit in hundreds of degrees F.
OFF	Setpoint for this channel is below lower temperature setpoint limit.
S-	Indicates Automatic Temperature Setback is disabled.
S-X	Indicates Automatic Temperature Setback is enabled, where: X is tens of minutes to Setback.
PS-	Waiting for operator to input new Password to lock system.
P-	Operator must enter Password to unlock system and change operating temperatures, temperature limits, or tip temperature offsets.

Table 2. Digital Readout Message Codes





QUICK REFERENCE - SYSTEM OPERATION

The Quick Reference Charts shown may be used as a guide for quickly changing any particular parameter stored within the **THERMAL MANAGEMENT CENTER** of the PRC 2000 system. Locate the parameter you wish to change in the column marked "ACTION" and follow the simple instructions given under "Procedure". Remember that if a password has been stored in the system, the password key sequence must be entered before making any changes.











ACTION	PROCEDURE
SELECT CURRENT CHANNEL	PRESS KEY → 
CHANGE SCALE °F/°C READOUT	PRESS KEY → 
ADJUST TIP OFFSET CONSTANT	KEYS →  →  or  → 
ADJUST SET TIP TEMPERATURE	KEYS →  →  or  → 

Table 3. Quick Reference Chart



ACTION	PROCEDURE
ENTER CALIBRATION (CAL) MODE	PRESS & HOLD TIP SET + POWER ON RELEASE AFTER 3 SECONDS TIP SET +
SET DEFAULT TEMP SCALE (°F/°C) **	PRESS KEYS TIP SET ▼ °C TIP SET POWER TIP OFFSET [] [] SET
TEMP LIMIT ** CHANGE LOWER	KEYS PRESS SET SET / SET SELECT SET TIP TIP CH TIP OF TIP TIP (Press) OFFSET (Twice)
TEMP LIMIT ** CHANGE UPPER	KEYS PRESS SET SET SELECT SET TIP TIP ▲ or ▼ SET TIP
AUTO TEMP SETBACK **	PRESS KEYS TIP SET [] or [] TIP SET TIP OFFSET
AUTO POWER DOWN **	Automatically enabled or disabled with AUTO TEMP SETBACK feature.

** SYSTEM MUST BE IN CALIBRATION (CAL) MODE.

Table 3. Quick Reference Chart Continued































ACTION	PROCEDURE
MANUAL SETBACK ON ALL ACTIVE CHANNELS	<p style="text-align: center;">PRESS & HOLD RELEASE AFTER 1 SECOND</p> <p style="text-align: center;">  +  →  +  </p>
EXIT SETBACK ON ALL ACTIVE CHANNELS	<p style="text-align: center;">PRESS & HOLD RELEASE AFTER 1 SECOND</p> <p style="text-align: center;">  +  →  +  </p>
ENTER PASSWORD MODE	<p style="text-align: center;">PRESS & HOLD RELEASE AFTER 1 SECOND</p> <p style="text-align: center;">  +  →  →  +  </p>
INSTALL PASSWORD	<p style="text-align: center;">PRESS KEYS →  →  →  → </p>
CHANGE PASSWORD	<p style="text-align: center;">PRESS KEYS →  →  →  → ENTER OLD PASSWORD →  → ENTER NEW PASSWORD →  →  → </p>
REMOVE PASSWORD	<p style="text-align: center;">PRESS KEYS → ENTER PASSWORD →  →  →  →  → </p>
<p style="text-align: center;">SYSTEM MUST FIRST BE PUT IN PASSWORD MODE. ** INITIATE PROCEDURE WITHIN 5 SECONDS OR SYSTEM WILL REVERT TO NORMAL OPERATION.</p>	

Table 3. Quick Reference Chart Continued

FOOT PEDAL

The foot pedal may be used with the PRC 2000 system in two different manners as described below.

1. **FOOT PEDAL** Receptacle - Connection of the foot pedal to this receptacle will allow the Pulse Heat (PH), Pulse Plate (PP), MicroChine (MC) and Pik & Paste (PD) features of the system to be actuated by the foot pedal. Electrical connection from the foot pedal to each feature is selected by positioning of the **FOOT PEDAL** Selector Switch.

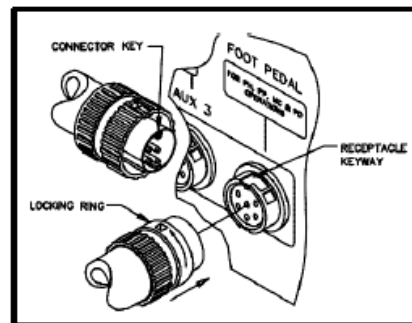

Figure 97. Foot Pedal Connection

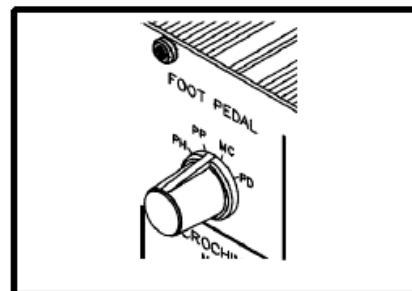

Figure 98. Foot Pedal Selector Switch

2. **THERMAL MANAGEMENT CENTER** - The foot pedal may be connected to any unused Output Receptacle (CH 1, 2 or 3 or AUX 1, 2 or 3) on the rear panel of the system. Depressing of the foot pedal when connected in this manner, will activate the vacuum pump to create vacuum at the **SNAP-VAC** Port or air pressure at the Controllable **PRESSURE** Port.

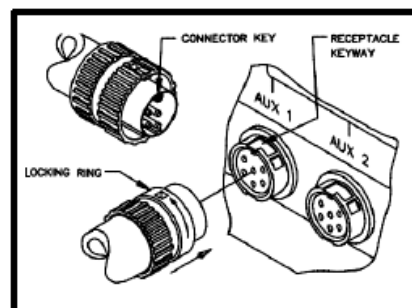

Figure 99. Aux. Foot Pedal Connection

PIK AND PASTE

Located in the middle of the front panel of the system power source, this portion of the PRC 2000 provides both a vacuum pick/placement capability (**PIK**) and a dispensing capability (**PASTE**) for use with a variety of solder cremes, high viscosity fluxes and adhesives. Refer to the "Capabilities" portion of this manual for a complete description of this feature. Following are the Set-Up and Operation instructions for each feature.

PASTE DISPENSER

SET-UP

1. Install the Dispenser Cubby (PACE P/N 6019-0038) provided with the system and install onto the left side of the system power source chassis. Assembly instructions are enclosed with the cubby.
2. Locate the Paste Dispenser Kit (PACE P/N 6993-0152) provided with the system.
3. Attach the ridged end of the male quick connect hose mount Fitting to the Air Hose.
4. Insert the male quick connect hose mount Fitting (attached to Air Hose) into the female **PASTE DISP** Port.

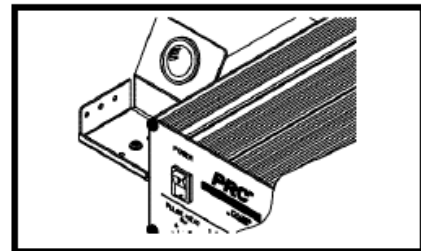

Figure 100. Dispenser Cubby Mounting

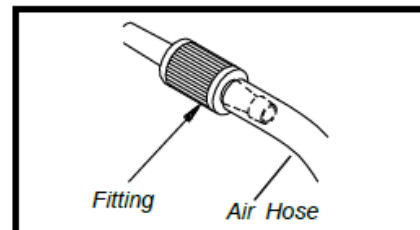

Figure 101. Air Hose Connection

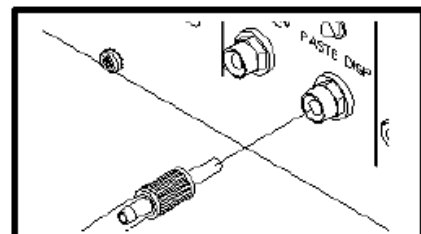

Figure 102. Paste Dispense Connection



SET-UP CONT'D

5. Slide the **Hose Clamp** over the free end of the **Air Hose**. Push clamp back 1 inch from the end of the **Air Hose**.
6. Attach the free end of the **Air Hose** to the nipple on the **Barrel Adapter** (10 cc adapter is supplied).
7. Secure the **Air Hose** to the **Barrel Adapter** by sliding the **Hose Clamp** down over the **Air Hose/Barrel Adapter** connection and screwing clamp down to secure in position.
8. Attach the **Barrel Adapter** to a barrel prefilled with material (not supplied). Place the barrel in the **Dispenser Cubby**.
9. Insure that the foot pedal is connected to the **FOOT PEDAL** Receptacle on the rear panel.
10. Set the **FOOT PEDAL** Selector Switch to the "PD" position.

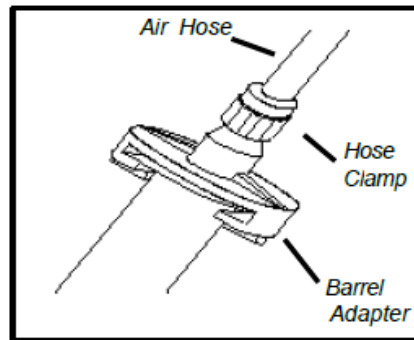

Figure 103. Barrel Adapter Connect.

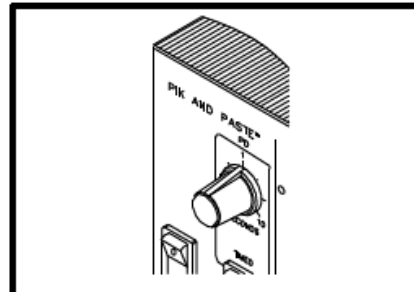

Figure 104. Foot Pedal Select. Switch



NOTE

When the Foot Pedal Selector Switch is set in the **PD** position, the dispense pump will run for a few seconds to provide a reservoir of pressurized air necessary for proper dispensing. The pump will also cycle every 2 minutes to maintain reservoir pressure.

OPERATION

PACE recommends that the operator become familiar with the operation of the dispenser by first applying the material to a piece of paper or scrap PC board. Use this method to obtain the desired results for each dispensing material and application.

MATERIALS USED FOR DISPENSING

CAUTION

Always refer to the Material Safety Data Sheet supplied with the material as a guide for proper handling and safety precautions.

Barrels prefilled with solder creams and brazing pastes of 400,000 to 600,000 centipoise viscosity may be dispensed using the needle size selections provided with your system.

NOTE

DO NOT attempt to dispense materials with viscosity levels lower than 400,000 centipoise. Low viscosity materials will not dispense properly.



MATERIAL LOADING

PACE recommends the use of prefilled barrels whenever practical to minimize any handling or safety precaution requirements. When loading is required, adhere to all precautions recommended by the material manufacturer. Refer to the Material Safety Data Sheet supplied with each material for information on important safety procedures and a listing of any toxic chemical elements.

NOTE
To assure consistent dispensing, fill the barrel to a level of no more than 2/3 of the barrel capacity.

Loading of high viscosity fluids may be accomplished using any of a number of available loading systems.

TIPSELECTION

Selection of the proper tip for the application is essential to obtain the optimum deposition rate and amount. Check the specifications of the material manufacturer for recommended tip sizing. The tip size and duration of the dispense cycle determine amount of material deposition (dot or bead size). Dispense several dots (or beads) onto a piece of paper or scrap PC board to check for desired results.

NOTE

Never install a clogged tip. The tip may be clogged with material used in a previous application. Install a new tip and discard after the required dispensing operation is completed.

Listed below are the four tip sizes available from PACE.

ITEM NO.	DESCRIPTION	PART NUMBER
1	Dispenser Tip, .023" LD., Pink (pkg. of 5)	1121-0409
2	Dispenser Tip, .020" LD., Purple (pkg. of 5)	1121-0410
3	Dispenser Tip, .016" LD., Blue (pkg. of 5)	1121-0411
4	Dispenser Tip, .013" LD., Orange (pkg. of 5)	1121-0412

Table 4. Available Dispenser Tips

DISPENSING MATERIAL

The operator may select the **Continuous (CONT)** or **TIMED** Mode of operation.

The **CONT** Mode allows the operator to dispense the material for as long as the foot pedal remains depressed. The **TIMED/CONT** Switch must be placed in the **CONT** position for use in this mode. This mode is recommended for use when dispensing a continuous bead of material.

The **TIMED** Mode allows the operator to select a dispense time of 0.1 to 10 seconds as determined by the **PASTE (DISP)** Timer Control. The **TIMED/CONT** Switch must be placed in the **TIMED** position for use in this mode. Use of this mode is recommended for all dot dispensing applications.

Follow the procedure below to obtain proper results.

1. Insure that the proper material and tip have been installed.
2. Set the **TIMED/CONT** Switch for the mode of operation desired. Set the switch to **CONT** for continuous operation or **TIMED** for timed operation.

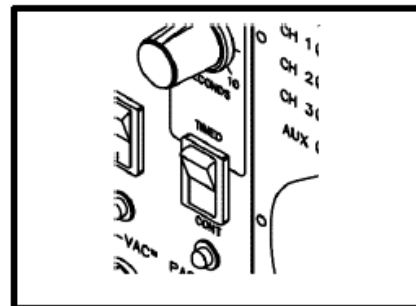

Figure 105. Timed/Cont Switch

3. If in the **TIMED** Mode, set the **PASTE (DISP)** Timer Control to the desired dispense time period.

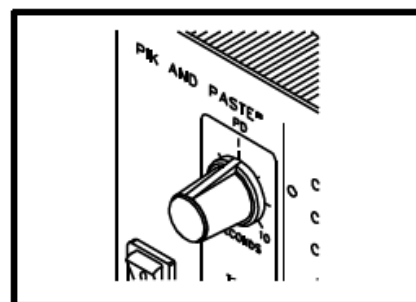

Figure 106. Paste Disp Timer

4. Holding the barrel as shown (at a 45° angle to the work), rest the tip on a piece of paper and dispense a small amount of material. This initial dispensing will fill the tip with material.
5. Wipe any material residue from the end of tip.
6. Hold the barrel as shown over the work area.
7. Depress the foot pedal to dispense material. The dispense cycle will remain on in the **CONT** Mode until the foot pedal is released. In the **TIMED** Mode, the cycle will continue for the period of time selected on the **PASTE DISP** Timer Control. The pump will turn on periodically to maintain reservoir air pressure. The **PASTE DISP** LED will illuminate throughout the dispense cycle and while the paste pump is running.

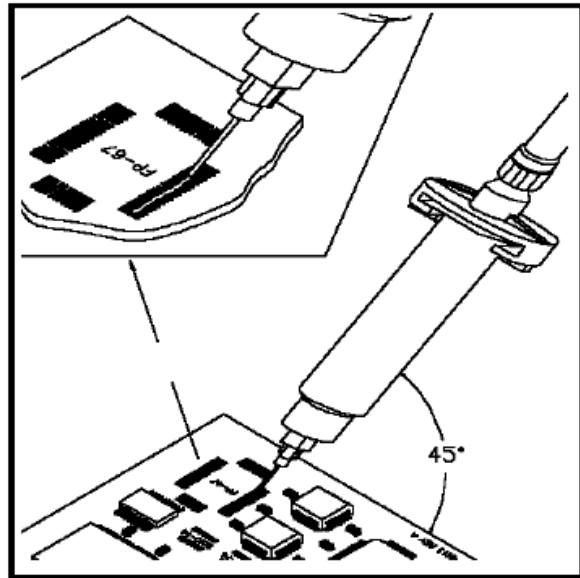

Figure 107. Paste Dispensing

8. Place barrel in Dispenser Cubby when dispensing operation is complete.

NOTE

Condensation may occur in the air hose after extended use. This is a normal occurrence.

DISPENSING SUGGESTIONS

1. Dispose of all tips and barrels after use. Always use new tips and barrels to prevent contamination, insure cleanliness and provide consistent, repeatable material deposition.
2. When dispensing different dot sizes, select a tip/time combination which dispenses small dots. These small dots may be dispensed in multiples to provide the deposition amount required. Use of the feature in this manner can eliminate frequent tip changes and dispense cycle time adjustments.
3. In situations where the metal tip may scratch or damage the work, install a short section of heat shrinkable tubing or teflon sleeving. The tubing (or sleeving) should extend 1.5 mm (1/16") past the tip end.
4. Keep all dispenser components clean to prevent clogging and/or irregular deposition.

VACUUM PICK

SET-UP

1. Locate the Pik-Vac (P/N 7027-0001-P1) and the Vacuum Cup Kit (P/N 6993-0154) supplied with the system.

2. Attach the ridged end of a male quick connect hose mount Fitting to each end of the Air Hose.

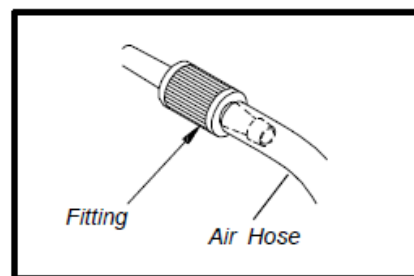

Figure 108. Air Hose Set-Up

3. Attach one male quick connect hose Fitting (with attached Air Hose) to the rear of the Pik-Vac Handpiece.
4. Insert the other male quick connect hose Fitting (with attached Air Hose) into the **PIK-VAC** Port.
5. Attach the Metal Vacuum Tip to the end of the Pik-Vac Handpiece.

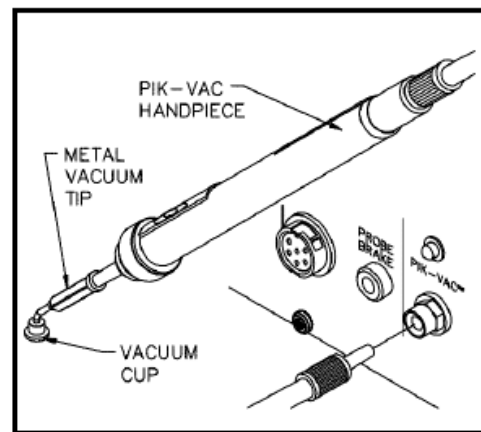

Figure 109. Pik-Vac Set-Up

OPERATION

1. Use of the Metal Vacuum Tip without a Vacuum Cup attached for removal/replacement of very small component works well but for larger components, install one of the supplied Vacuum Cups onto the tip. For best results, use a size slightly smaller than the body of the component to be removed or placed. For very large components, use the largest Vacuum Cup.
2. Place the **PIK-VAC** Power Switch in the "ON" (1) position to activate vacuum at the handpiece. **The PIK-VAC LED** will illuminate whenever the switch is "ON".
3. Grasp the handpiece as you would a pen with the Vacuum Cup (or tip) pointing down and the Vacuum Control Port (refer to illustration on following page) pointing up.

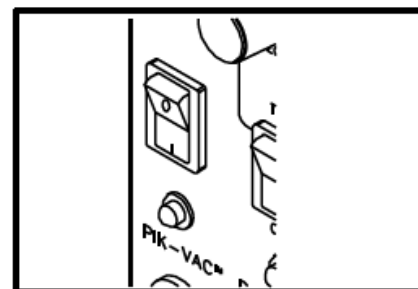

Figure 110. Pik-Vac Power Switch

OPERATION CONT'D

4. Place the Vacuum Cup and/or the Metal Vacuum Tip gently onto the top surface of the Component body. Exercise caution to avoid bending of leads on fine pitch devices.
5. Place one finger over the Vacuum Control Port. Vacuum is now being applied to the Component body.
6. Gently lift the Component off the PC Assembly (removal operation) or out of the component holder (placement operation).
7. Lower the Component gently into position onto the PC Assembly (placement operation) or component holder (removal operation).
8. Lift finger or gently slide finger back from the Vacuum Control Port to release the Component.
9. Place the **PIK-VAC** Power Switch in the "OFF" (0) position when all Component handling operations are completed.

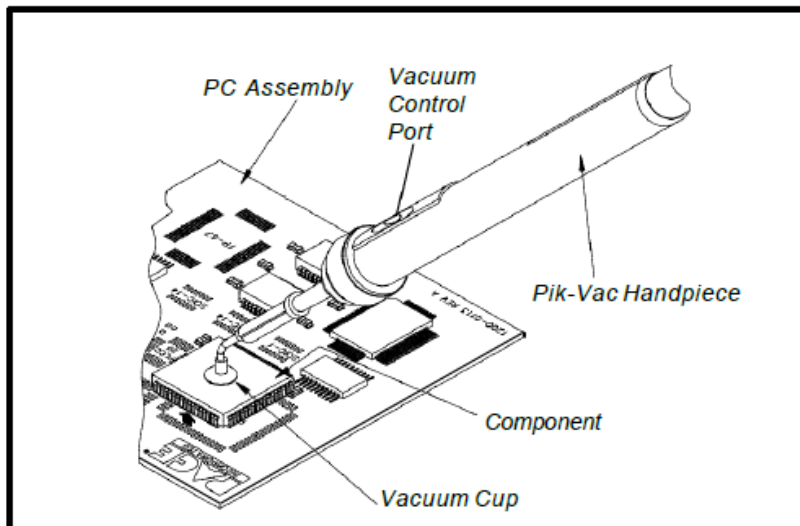

Figure 111. Pik-Vac Operation

MICROCHINE

The PACE MicroChine handpiece has a number of unique features which are not available in any other motorized, hand-held machining tool. The user is provided with a broad range of machining capabilities required in the repair, rework, modification, prototyping and manufacturing of printed circuit boards and electronic assemblies.

This lightweight, variable speed, static dissipative, hand-held machining instrument offers the user a primary handpiece with the torque and adjustable rotational speed needed to perform a number of controlled drilling, milling and abrading tasks under varying loads.

The Probe Brake feature was developed to help you when repairing multilayer printed circuit boards. In use, a lead is connected between the **PROBE BRAKE** Receptacle on the front panel of the power source and a surface or inner layer conductor (land, trace etc.) on the circuit board. During excavation or drilling tasks when the MicroChine drill or mill contacts this desired conductor, the brake circuit is activated and stops the motor instantly. This allows very accurate and precise nondestructive excavation on multilayer assemblies to the exact depth required.

The MicroChine Status Indicator LED illuminates Green in color when the MicroChine handpiece is activated, Amber in color in maximum torque mode and Red in color when Probe Brake circuit is activated. Electrical power input can be controlled with the integral finger switch conveniently located in the handpiece or with the foot pedal.

SET-UP

1. Insure that the POWER Switch is in the "ON" position.
2. Connect the MicroChine handpiece power cable connector to the MicroChine Power Receptacle.

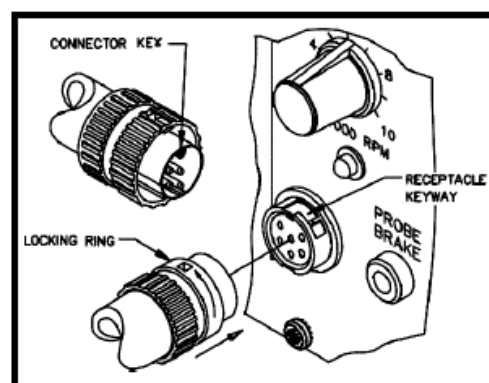

Figure 112. MicroChine Attachment



SET-UP CONT'D

3. Adjust the MicroChine Variable Speed Control to the desired rotational speed. Speeds are available from 2500 to 10,000 R.P.M. On any task, start with a lower speed and increase it within your control.

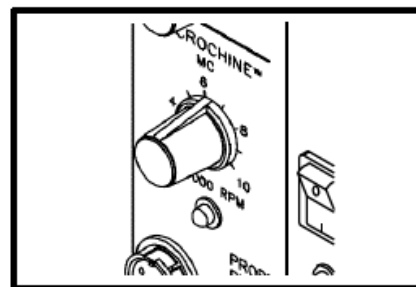

Figure 113. MC-65 Speed Control

4. Select and attach the desired drill, mill or abrasive tool for the task at hand. Insert a small drill bit into the access hole in the MicroChine housing and shaft to lock the shaft in position when removing or installing a tool.

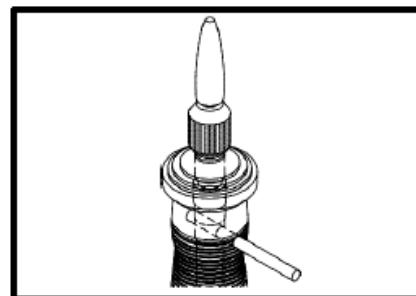

Figure 114. Tool Attachment

5. There are two power switching options, the finger switch on the handpiece, or the foot pedal control. When use of the foot pedal is desired, the pedal must be attached to the **FOOT PEDAL** Receptacle at the rear panel of the system power source.

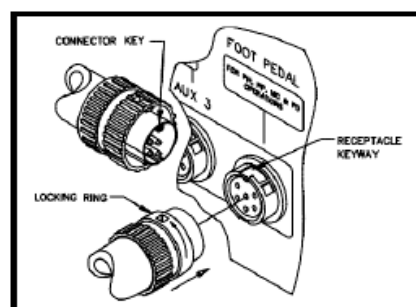

Figure 115. Foot Pedal Connection



6. Set the **FOOT PEDAL** Selector Switch to the MicroChine (**MC**) position when foot pedal actuation is desired. In this mode either the finger switch on the handpiece or the foot pedal can actuate the MicroChine.

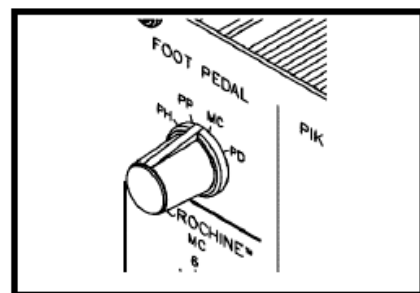

Figure 116. Pedal Selector Switch

7. Connect the Probe Brake Lead jack to the **PROBE BRAKE** Receptacle and the clip end to a conductor (which has continuity with the conductor (s)) you want to protect. See "Workpiece Grounding".

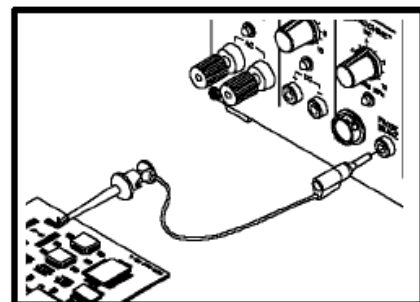

Figure 117. Probe Brake Attach.

PROBE BRAKE OPERATION

The MicroChine's Probe Brake feature instantly stops all rotary machining at a selected layer depth for nondestructive multilayer repair.

In use, the Probe Brake cable is attached to the **PROBE BRAKE** Receptacle on the front panel of the system power source. The opposite end of the Probe Brake cable must be connected to a connector pin, component lead, or a soldered-on extension of the circuit board assembly. The connection point must have electrical continuity with the internal conductor to be repaired. A schematic diagram or layout artwork of the printed wiring assembly (PWA) is a great aid in locating the most effective connection point for the Probe Brake cable. The electronic Probe Brake circuit stops the MicroChine instantly when the working drill or mill makes contact with the internal layer of circuitry, in continuity with the Probe Brake lead, and the Status LED illuminates Red in color. Once the brake circuit has stopped the motor, the finger switch or foot pedal must be released before the motor can be started again.

WORKPIECE GROUNDING

The Probe Brake may activate prematurely if the workpiece is attached directly to ground. The Probe Brake circuit operates when a connection is made between the MicroChine bit and the conductor to which the Probe Brake Lead clip is attached; a low current flows through this connection to activate the Probe Brake. Low resistance to ground or high capacitance in the workpiece circuit connected to the Probe Brake lead may activate the electronic sensing circuitry, in continuity with the Probe Brake lead, in the system power source. In this case, PACE recommends the use of the **PROBE BRAKE** Receptacle to ground the workpiece. To prevent electrostatic build-up, this receptacle provides an impedance of 1,000 ohms to ground.

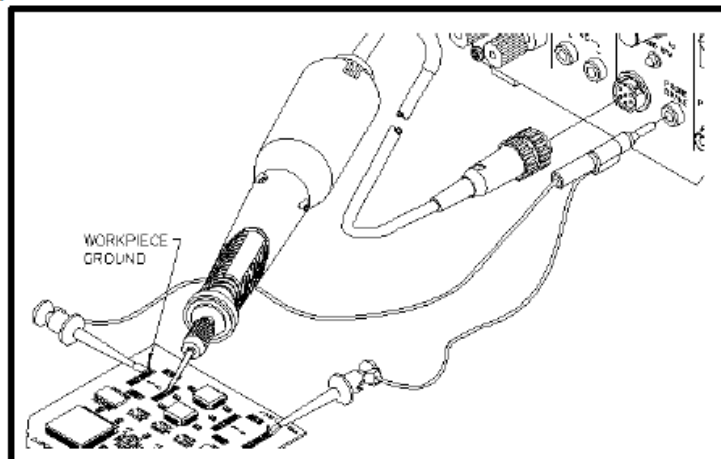

Figure 118. Workpiece Grounding

PULSE PLATE

The PACE PRC 2000 system provides the DC electrical power, voltage level control power receptacles and LED indicator for controlled miniature plating. The LED indicator illuminates Green during normal operation and Red in short circuit or over current conditions.

Electronic current sensing and switching is built into the pulse plating power supply. This innovative capability protects the workpiece from burning and from electrical arcing should the carbon electrode become exposed through the cotton swab during the swab plating process.

SET-UP

1. Set the **POWER** switch to the "ON" (1) position.

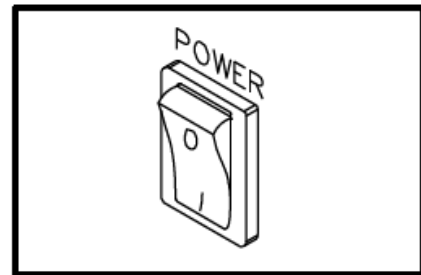

Figure 119. Power On

2. Set **FOOT PEDAL** Selector Switch to the **PULSE PLATE (PP)** position.

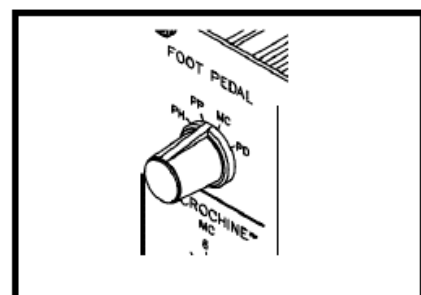

Figure 120. F.P. Selector Switch



SET-UP CONT'D

3. Insure that the foot pedal is attached to the **FOOT PEDAL** Receptacle on the rear panel of the power source.

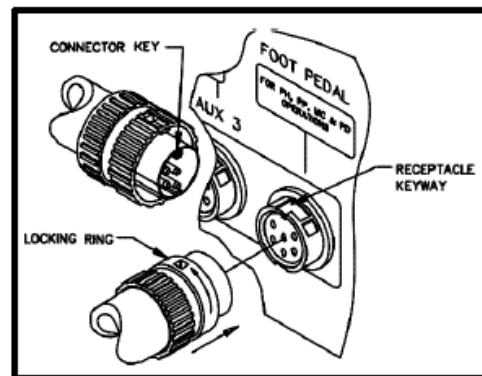

Figure 121. Foot Pedal Connection

4. Place foot pedal in a convenient position on the floor beneath the workstation.
5. Open the Model PE-210 SwaPlater Kit and study the enclosed operation manual if you are not familiar with the system.
6. Remove the two power cords from the SwaPlater case.
7. Attach the Swatplater power cords to the **PULSE PLATE** Outputs. Connect the Black power cord to the Black (-) receptacle and the Red power cord to the Red (+) receptacle.
8. Set the **PULSE PLATE** Output Control to the proper voltage for the plating task required. See Swaplater Model PE-210 Operation and Maintenance Manual for complete details on plating procedure.

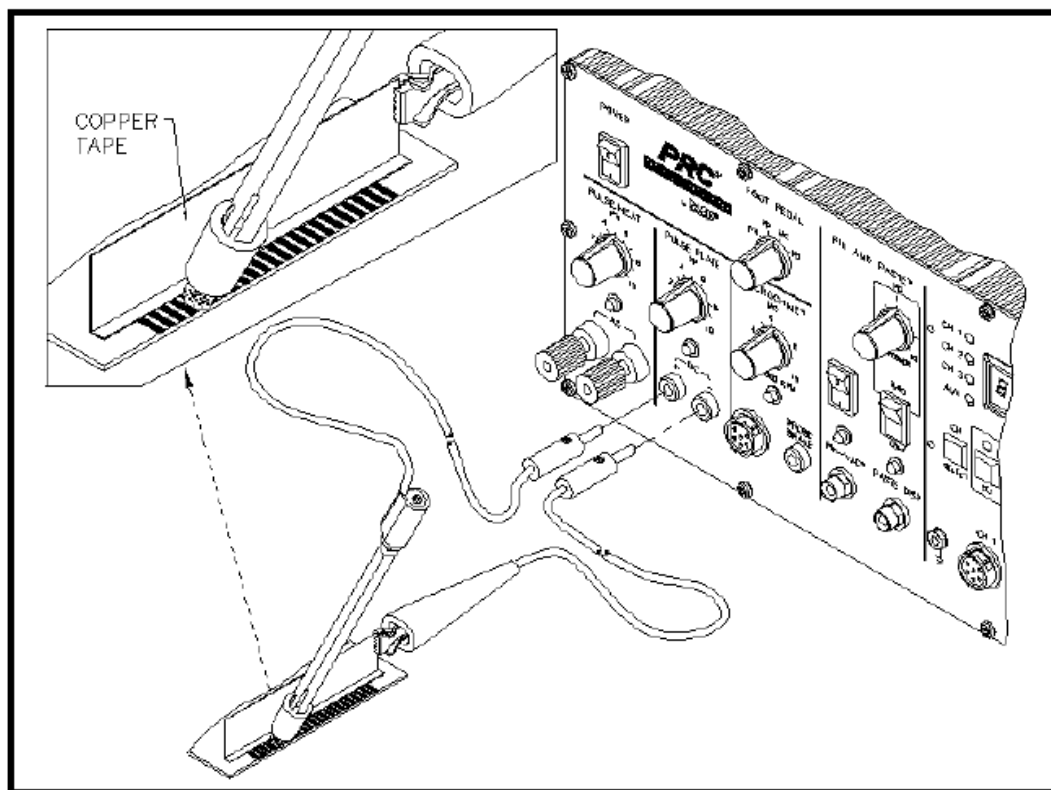

Figure 122. Pulse Plate Set-Up



PULSE HEAT

Located on the extreme left side of the PRC 2000 system, the **PULSE HEAT** section features a power output which provides controlled temperature ramp-up to solder reflow and rapid cool down. This controlled temperature ramp-up helps reduce the risk of thermal shock damage to components and substrates in combination with other measures such as preheating with the PACE HotSpot. A variety of rapid connect/disconnect handpieces allow the operator to perform many different SMD removal/replacement tasks which may be required for any particular repair process. Refer to the "Capabilities" portion of this manual for a complete description of **PULSEHEAT** functions.

SET-UP

1. Install the Redi-Rak handpiece storage holder onto the top of the system power source. Complete installation instructions are included with the Redi-Rak.
2. Insure that the foot pedal connector plug has been connected to the **FOOT PEDAL** Receptacle located on the rear panel of the power source.
3. Set the **PULSE HEAT** Output Control to "0".

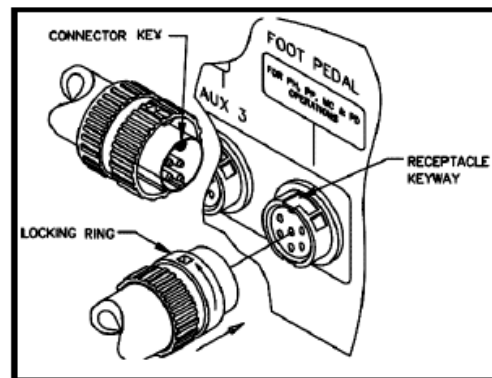

Figure 123. Foot Pedal Connection

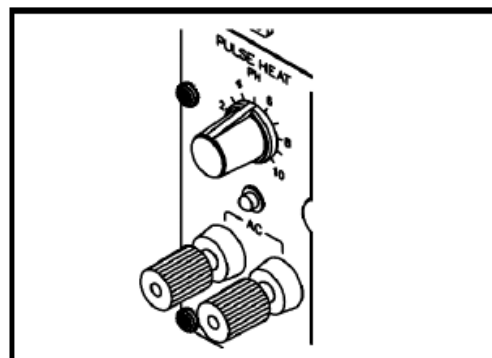

Figure 124. Pulse Heat Control



SET-UP CONT'D

4. Attach the Universal Power Cord to the **PULSE HEAT** Outputs as shown.

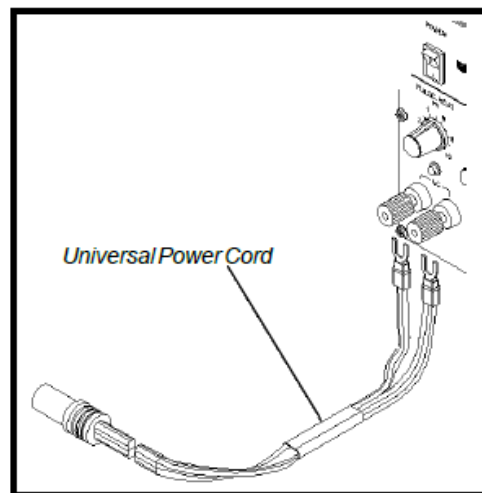

Figure 125. Universal Power Cord

5. Attach the proper tip for the task at hand, to the selected handpiece. Refer to the Pulse Heat Reference Guidelines for recommended tip/handpiece selection and **PULSE HEAT** Output Control settings.

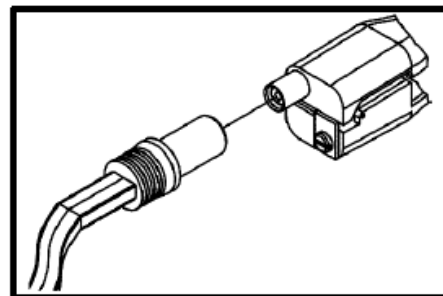

Figure 126. Handpiece Attachment

6. Attach selected handpiece to the Universal Power Cord as shown.
7. Insure that the **PULSE HEAT** Output Control is adjusted to "0".

OPERATION

1. Set the **FOOT PEDAL** Selector Switch on the system front panel to the Pulse Heat (**PH**) position.

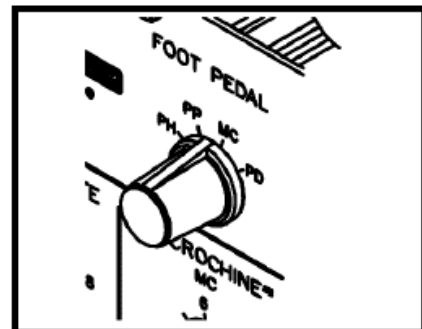

Figure 127. Pedal Selector Switch

2. Press foot pedal and adjust the **PULSE HEAT** Output Control. Increase output level until selected tip heats to desired level. The Green colored Pulse Heat LED will remain illuminated as long as the foot pedal is depressed.

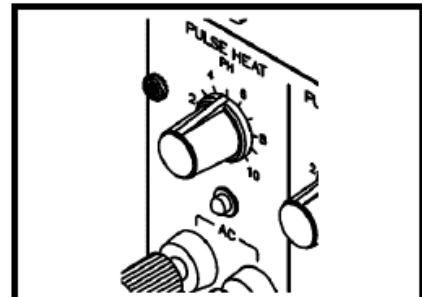

Figure 128. Pulse Heat Output

CAUTION

Overheating and premature failure of tips may result if a high level of power is applied and/or the tip is not in direct contact with a solder joint(s). In most cases, the tip should not be heated unless in contact with a solder joint(s).

3. Refer to handpiece manual for recommended component removal/replacement procedures.

REFERENCE GUIDELINES

The **PULSE HEAT** Output Control reference guidelines listed in the table below are recommended by PACE as base reference parameters only. In each application, **PULSE HEAT** Output Control adjustments may be necessary. Start with the applicable setting listed below and increase output level in small increments until desired results are achieved.







COMPONENT TYPE	OPERATION	# LEADS OR SIZE	TIP USED	TIP OUTLINE	OUTPUT LEVEL
	REMOVAL	18	1121-0294		7
		18-DRAM	1121-0372		7
		20	1121-0295		7
		28	1121-0296		8
		32	1121-0348		9
		44	1121-0297		10
 PLCC (J LEAD)	REPLACEMENT	18	1121-0298		3
		20	1121-0298		3
		28	1121-0300		3
		44	1121-0299		3
 EXTENDED LEAD	REPLACEMENT	Sngl. Point	6000-0008		3
		0.270"	1121-0298		3
		0.540"	1121-0299		3
		0.440"	1121-0300		3
 CHIP COMPONENT	REMOVAL & REPLACEMENT	VARIABLE	1121-0286		5

Table 5. Pulse Heat Reference Guidelines

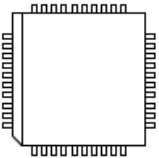
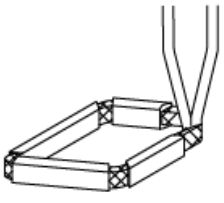

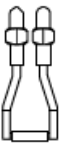
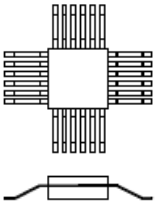
CAUTION

For continuous use, the Output Level settings listed in Table 5 are the maximum recommended values. Exceeding these levels for extended periods may sometimes cause the handle to get hot.



COMPONENT TYPE	OPERATION	# LEADS OR SIZE	TIP USED	TIP OUTLINE	OUTPUT LEVEL
 SOT	REMOVAL & REPLACEMENT	3	1121-0269		7
 SOIC	REMOVAL	8	1121-0269		6
		14, 16	1121-0271		6.5
		20	1121-0270		6.5
		24, 28	1121-0293		6.5
CONNECTOR TERMINAL SOLDERING	REMOVAL & REPLACEMENT	ANY	1121-0301		6
			1121-0009		6
			1121-0006		6
COATING REMOVAL	REMOVAL	POLY U	6000-0009		2
		EPOXY			2.5
WIRE STRIP	REMOVAL	PVC, RBR	1121-0003		2-3
		TEFLON			3-6

Table 5. Pulse Heat Reference Guidelines Cont'd

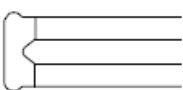
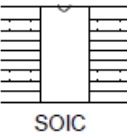
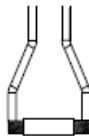
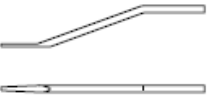
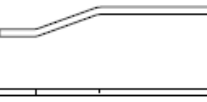
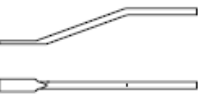

VISIFILTER ELEMENT REPLACEMENT

Follow the procedure listed below to replace the VisiFilter element when it becomes clogged or discolored.

1. Disconnect the handpiece air hose by gently turning and pulling the coupled Fittings.
2. Disconnect the Visifilter and hose assembly from the Power Source by gently turning and pulling the male Fitting inserted into the **SNAP-VAC** Port.
3. Disconnect VisiFilter from both attached 1 inch air hoses by gently turning and pulling the VisiFilter while holding each of the hoses.
4. Separate the 2 plastic housing halves of the VisiFilter in the following manner.
 - a) Grasp the VisiFilter in the palm of the hand with the Male Nib (air hose connection) marked "FLOW IN" facing you.
 - b) Pull against one of the Wing Tabs while pulling on the Male Nib with the free hand to open the interconnection of the plastic housings at that Wing Tab.
 - c) Pull against the second Wing Tab while pulling on the Male Nib to open the remaining interconnection and separate the plastic housings.
5. Remove the old or discolored Element and discard.
6. Insert the replacement VisiFilter Element into the housing marked "FLOW IN". Center the Element in the housing well.
7. Squeeze the 2 plastic housing halves together using 4 plastic Bumps on the housing marked "FLOW OUT" as pressure points. The 2 plastic housings will snap together and lock the VisiFilter Element in position.
8. Reconnect the 1 inch air hoses (removed in step 3) to the VisiFilter.
9. Attach VisiFilter and hose assembly to Power Source by inserting male Fitting into the **SNAP-VAC** Port.

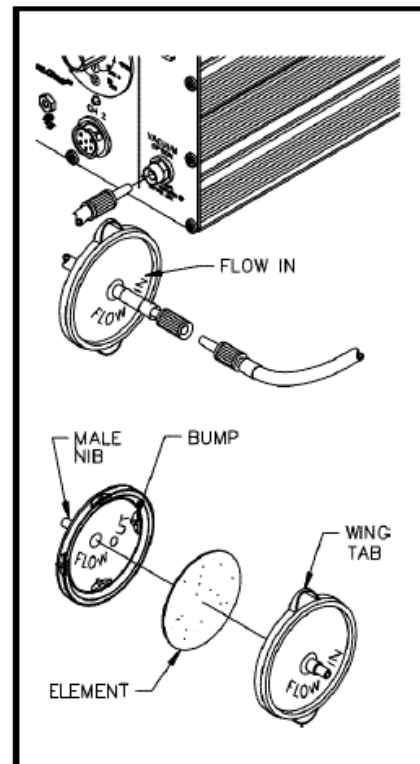

Figure 129. VisiFilter Element Replacement



HANDPIECES

Use the Digital Readout Message Codes ("E-1" & "E-2") listed on Table 6 (under "POWER SOURCE") as a guide to pinpointing any malfunction associated with the handpiece. Refer to Operation and Maintenance Manual applicable to handpiece for instructions on troubleshooting that particular handpiece. The following "Heater Assembly Checkout Procedures" are applicable to all PACE SensaTemp handpieces except for the TT-65 ThermoTweez and DTP-80 Dual ThermoPik handpieces. Refer to either of the TT-65 manuals (P/N 5050-0300 or 5050-0336) for troubleshooting procedures pertinent to that handpiece.

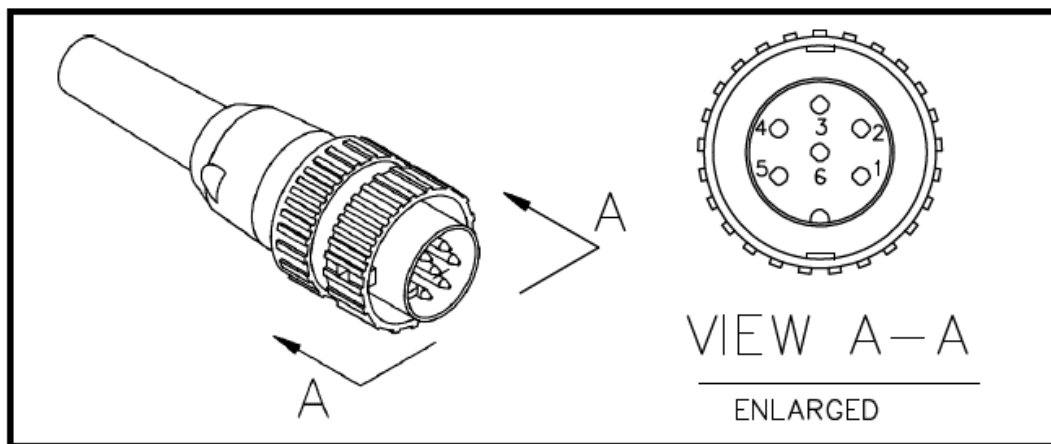

Figure 130. Handpiece Connector Plug



NOTE

Perform the "Heater Assembly Checkout Procedures" shown below with the handpiece (and heater) at room temperature. If the handpiece is warm, resistance reading will be different from those shown in the table below.

SYMPTOM	CHECKOUT PROCEDURE	CAUSE	SOLUTION	HEATER SPECIFICATIONS
No heat	Check resistance - Pin 2 to Pin 5. Refer to "Heater Specifications" column. If resistance is high - -	Open Heater	Replace Heater Assembly.	SX-70 = 8 - 10 ohms SP-1A = 10 - 12 ohms SP-2A = 8 - 10 ohms TP-65 = 9 - 11 ohms TJ-70 = 6 - 8 ohms
	Check resistance - Pin 3 to Pin 6. If circuit reads open - -	Open Sensor	Replace Heater Assembly.	
Handpiece overheating	Check resistance - Pin 3 to Pin 6. Resistance should be 110 ohms. If resistance reading is less than 105 ohms - -	Shorted Sensor	Replace Heater Assembly.	
Fuse blows when unit is turned on.	Check resistance - Pin 2 to Pin 5. Refer to "Heater Specifications" column. If resistance is low - -	Solder short in Handpiece.	Remove Short. Replace Heater Assembly & Fuse F1.	
		Shorted Heater	Replace Heater Assembly & Fuse F1.	
No Ground on Tip.	Check resistance - Pin 4 to a NEW Tip. Resistance should be less than 2 ohms. If not - -	Oxidation buildup in Heater Bore.	Clean Heater Bore using appropriate wire brush.	
		Defective Heater	Replace Heater Assembly.	

Table 6. Heater Assembly Checkout Procedures

POWER SOURCE

SYMPTOM	PROBABLE CAUSE	SOLUTION
Digital Readout is blank. No functions on system.	Blown Fuse (F1)	Replace Fuse F1 located on rear of Power Source in the AC Receptacle.
Digital Readout is blank. Some functions work.	Low AC line voltage.	Check line voltage.
	Microprocessor pcb defect.	Contact PACE Service Department.
E-1 displayed on Digital Readout.	All Channels are unplugged on Thermal Mgmt. Center.	Plug handpiece into CH 1, CH 2 OR CH 3.
	Open sensor in handpiece.	Refer to handpiece Operation Manual for Corrective Maintenance procedures.
E-2, E-3 or E-4 displayed on Digital Readout.	Defective heater assembly in handpiece.	Unplug all handpieces. Plug handpieces back in one at a time. When defective handpiece is connected, "E" code will be displayed. Refer to handpiece Operation Manual.
No heat on handpiece(s) at Thermal Management Center.	Open heater.	Refer to handpiece Operation Manual.
	Blown 12 Amp Fuse.	Replace 12 amp Fuse located on rear of Power Source.
	Handpieces connected to AUX receptacles. SP & SX series handpieces are not AUX compatible.	Disconnect incompatible handpieces from AUX Receptacles. Connect to Power Receptacles on front panel.
	Damaged Power Receptacle.	Contact PACE Service Department.
	System overload. Check for defective handpiece.	Disconnect defective handpiece. 220 Volt version only: Overtemp cutout in transformer may open. Allow transformer to cool.
	Microprocessor pcb defect.	Contact PACE Service Department.

Table 7. Corrective Maintenance, Power Source



SYMPTOM	PROBABLE CAUSE	SOLUTION
Foot Pedal does not activate vacuum or air pressure for Thermal Management Center.	Foot Pedal connected to incorrect receptacle for Thermal Mgt. Center motor pump activation.	Connect Foot Pedal to any spare AUX Power Receptacle on Thermal Management Center.
	Defective motor pump.	Contact PACE Service Department.
	Microprocessor pcb defect.	Contact PACE Service Department.
Keys on Thermal Management Center don't function properly.	Key caps binding.	Clean and/or adjust Key caps.
	Display pcb misaligned or defective.	Contact PACE Service Department.
	Microprocessor pcb defective.	Contact PACE Service Department.
Cannot adjust Offset or Set Tip Temperature on Thermal Management Center. Digital Readout displays "P--".	System is requesting Password entry.	Enter Password.
	Operator forgot Password.	Clear Password. See "Clearing a Password" instructions.
Digital Readout on Thermal Management Center is grossly inaccurate.	System out of calibration.	Wait 4 minutes for system to perform automatic internal recalibration.
	Shorted handpiece or accessory connected to AUX or Power Receptacle.	Disconnect handpieces and accessories. Repair defective handpiece or accessory.
	Defective Microprocessor pcb.	Contact PACE Service Department.

Table 7. Corrective Maintenance, Power Source Cont'd



POWER SOURCE CONT'D

SYMPTOM	PROBABLE CAUSE	SOLUTION
Insufficient SNAP-VAC (vacuum) or air pressure. Excessive motor pump noise.	Air hose(s) and/or filter(s) clogged.	Replace any clogged filters and clear all air hoses.
	Defective motor pump.	Contact PACE Service Department.
	Microprocessor pcb defect.	Contact PACE Service Department.
Digital Readout display is erratic.	Shorted handpiece or accessory.	Disconnect handpieces and accessories one at a time until Digital Readout display is normal.
	Low AC line voltage.	Check line voltage.
	Display pcb defective.	Contact PACE Service Department.
	Microprocessor pcb defective.	Contact PACE Service Department.
Paste dispenser timing is grossly inaccurate.	Multifunction pcb is defective or requires adjustment.	Contact PACE Service Department.
Paste dispenser pressure is insufficient or nonexistent.	Poor air hose connections.	Check air hose connections outside and inside of system power source.
	Clogged air filter.	Replace filter.
	Defective pump, valve or reservoir.	Contact PACE Service Department.
Excessive noise during paste dispense operation.	Defective dispense pump	Contact PACE Service Department.
	Defective Multifunction pcb.	Contact PACE Service Department.

Table 7. Corrective Maintenance, Power Source Cont'd



SYMPTOM	PROBABLE CAUSE	SOLUTION
MicroChine Status LED continuously illuminated in color.	Red Shorted handpiece or accessory on Thermal Management Center.	Disconnect handpieces and accessories one at a time (& run MicroChine) until LED turns off.
	Multifunction pcb defect.	Contact PACE Service Department.
MicroChine Probe Brake activates prematurely.	Probe Brake test lead is connected to or exciting a circuit having less than 500 ohms resistance to ground.	Remove ground lead from pcb.
MicroChine continues to run after release of finger switch or foot pedal.	Defective MicroChine handpiece.	Replace MicroChine handpiece.
MicroChine Probe Brake reacts sluggishly or is inoperable.	Probe Brake test lead is connected to inappropriate conductor on workpiece.	Connect Probe Brake test lead to proper conductor.
	Bit in MicroChine is not conductive (non metallic).	Install conductive bit.
	Defective MicroChine handpiece.	Replace handpiece.
	Multifunction pcb defective.	Contact PACE Service Department.
MicroChine will not operate. Probe Brake LED is illuminated Green in color.	Damaged Power Receptacle.	Contact PACE Service Department.
	Defective MicroChine handpiece.	Replace handpiece.
	Multifunction pcb defective	Contact PACE Service Department

Table 7. Corrective Maintenance, Power Source Cont'd



POWER SOURCE CONT'D

SYMPTOM	PROBABLE CAUSE	SOLUTION
MicroChine speed is grossly inaccurate.	MicroChine is overloaded. Status LED is illuminated Yellow in color.	Disengage MicroChine from workpiece. Resume operation exerting less pressure on handpiece.
	Defective handpiece.	Replace handpiece.
	Multifunction pcb defective or requires adjustment.	Contact PACE Service Department.
Pik-Vac has insufficient vacuum.	"Low Pressure" output on power source rear panel is obstructed.	Remove obstruction.
Pulse Heat handpieces do not heat. Pulse Heat LED is illuminated Green in color.	Loose connection at Pulse Heat Outputs or handpiece connector.	Tighten connections.
	Multifunction pcb defective.	Contact PACE Service Department.
Foot Pedal does not operate in PH, PP, MP or PD position.	Foot pedal connected to incorrect receptacle.	Connect foot pedal to receptacle on rear panel of power source marked "FOOT PEDAL".
	Multifunction pcb defective.	Contact PACE Service Department.
	Broken wire in harness.	Contact PACE Service Department.

Table 7. Corrective Maintenance, Power Source Cont'd





POWER SOURCE

Listed below are the power source parts which may be ordered directly from PACE sales or your local authorized PACE distributor. For handpiece replacement parts, refer to the associated Operation and Maintenance Manual. To obtain power source parts other than those shown, contact your local PACE distributor or PACE Service Department directly at Telephone (301) 490-9860, Fax (301) 483-7030.

ITEM NO.	DESCRIPTION	PACE PART NUMBER	
		PPS 400 PPS 400J	PPS 400E
1	Fuse (F1) 5.0 Amp, Time Lag	1159-0253	-----
	2.5 Amp, Time Lag	-----	1159-0220
2	Fuse (F2) 12.0 Amp, Fast Acting	1159-0257	1159-0257
3	Power Cord (not shown in illustration)	1332-0094	1332-0093
4	VisiFilter (not shown in illustration)	1309-0028	1309-0028
5	VisiFilter Replacement Elements	1309-0027-P50	1309-0027-P50

Table 8. Power Source Replacement Parts

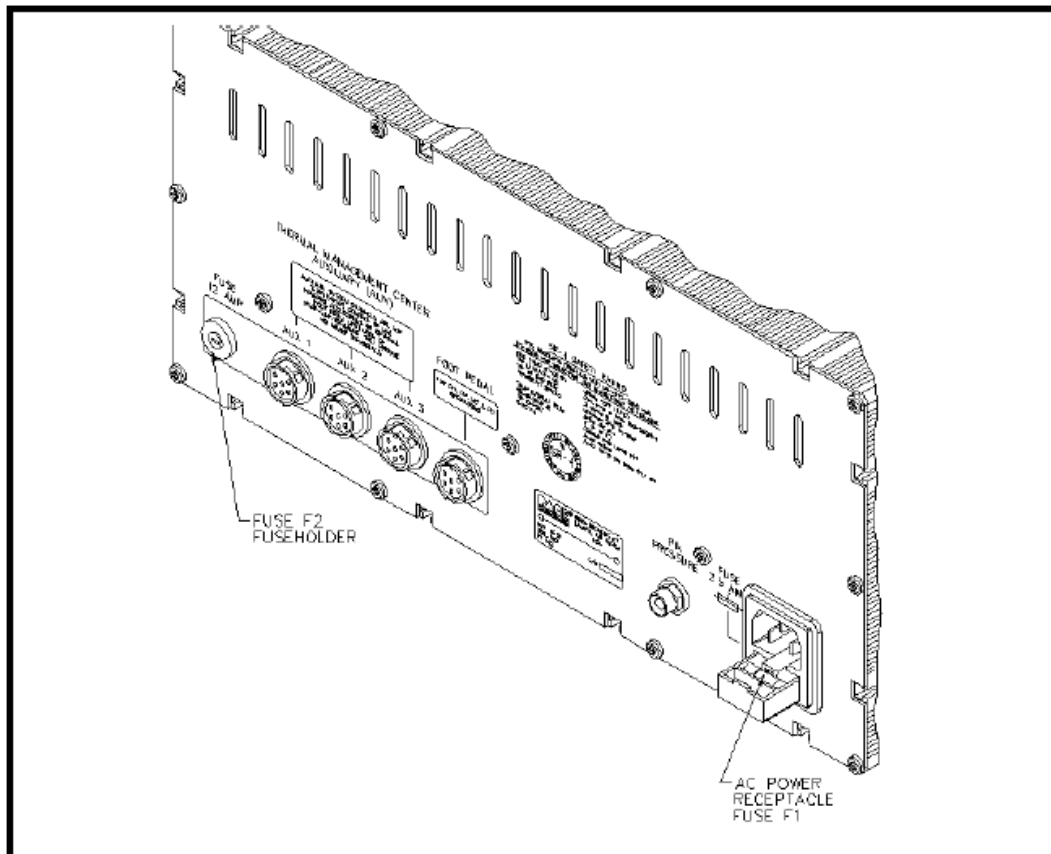

Figure 131. Power Source Rear Panel

SYSTEM PACKAGING

The tables on the following pages detail handpieces and accessory items available for use with the PRC 2000 systems. The handpieces and accessories supplied standard with each system version (e.g., Standard Version) are listed in the current revision of the PACE Price/Parts book. Contact your local authorized PACE distributor for additional information.



SYSTEM HANDPIECES

Item Number	Description	Part Number
<i>SensaTemp Handpieces</i>		
1	SP-2A Sodr-Pen	6025-0014
2	SP-1A Sodr-Pen	6025-0013
3	SX-70 Sodr-X-Tractor	6010-0077
4	TJ-70 Mini ThermoJet	7023-0002
5	TP-65 ThermoPik	7024-0001
6	TT-65 ThermoTweez	7025-0001
<i>Tip & Tool Stands for SensaTemp Handpieces</i>		
7	SP Tip & Tool Stand (used with items #1 & 2 above)	6019-0043
8	SX Tip & Tool Stand (used with items #3, 4 & 5 above)	6019-0044
9	TT Tip & Tool Stand (used with item #6 above)	6019-0046
10	Tip & Tool Stand Redi-Rak	6021-0008
<i>Pulse Heat Handpieces</i>		
11	LF-15 LapFlo	7013-0004-02
12	TW-15 ResisTweez	7009-0005
13	CT-15 ConducTweez	7020-0001
14	TS-15 StripTweez	7012-0002
15	Universal Power Cord (used with all pulse heat handpieces)	7000-0023
16	Handpiece Cubby	6019-0022
17	Handpiece Redi-Rak	6019-0023
<i>Special Application Handpieces</i>		
18	MC-65 MicroChine	7026-0001
19	Probe Brake Patch Cord	1332-0159
20	Accessory Tool Kit	6005-0013
21	PV-65 Pik-Vac Vacuum Wand	7027-0001
22	Accessory Kit (assorted needles & vacuum cups)	6993-0154

Table 9. System Handpieces



SYSTEM ACCESSORIES

Item Number	Description	Part Number
1	Tip Maintenance Station	6993-0138
2	Replacement Sponge for Tray (7 pieces)	4021-0007-P7
3	Fiber Cleaning Tool (for Surface Mount tips)	1100-0232
4	Replacement Fiber Filler (pkg. of 2)	1127-0013-P2
5	Sponge Cleaning Tool (for Surface Mount tips)	1100-0233
6	Replacement Sponge Filler (pkg. of 5)	4021-0006-P5
7	Thermal Insulative Handpiece Sleeve (all SensaTemp Air Handpieces)	1346-0065
8	Tip Redi-Rak	6021-0007
9	Foot Pedal	6008-0115
10	Tip & Temperature Selection System Charts Booklet	5050-0251
11	Tip & Temperature Selection System Chart Holder	1257-0186-P1
12	Paste Dispenser Cubby	6019-0038
13	Accessory Kit for Paste Dispenser	6993-0152
14	Power Source Interlock Kit	6993-0141
15		
16	Vacuum Tubing, Translucent Silicone (54" length)	1342-0001-13
17	Paste Dispense Tubing, Clear PVC (36" length)	1325-0003-10
18	Quick-Disconnect Insert (Male)	1259-0087
19	Quick-Disconnect Insert (Female)	1259-0086
20	Cable Marker Kit (Colored Tabs for hose/cord identification)	6993-0136
21	Wire Brush, 3/16" Diameter	1127-0014
22	Wire Brush, 1/8" Diameter	1127-0006
23	Tip Cleaner Kit	6993-0151
24	PACE Screwdriver	1100-0230
25	Service Manual	5050-0344

Table 10. System Accessories



SENSATEMP HANDPIECES

Listed below are available SensaTemp handpieces. These items may be ordered directly from PACE or through your local authorized PACE distributor.

1. SP-2A Sodr-Pen Soldering Iron - P/N 6025-0014 - Provides a wide range of SMD and thru-hole installation and removal capability as well as unsurpassed thermal performance on heavy multilayer thru-hole assemblies at safe, lower working temperatures. A wide variety of 3/16" shank , quick change thru-hole and SMD tips (for chip components, SOTs, SOICs and other components) are available.
2. SP-1A Sodr-Pen Soldering Iron - P/N 6025-0013 - Uses 1/8" shank tips and features a slimmer, more compact heater than the SP-2 Sodr-Pen for easier access on densely populated assemblies.
3. SX-70 Sodr-X-Tractor Handpiece - P/N 6010-0077 - Provides enhanced thermal performance for safe, rapid desoldering of heavy multilayer thru-hole solder joints. Also ideal for SMD land preparation on heavy multilayer assemblies. A wide variety of standard, heavy duty and low cost tips are available.
4. TP-65 ThermoPik Handpiece - P/N 7024-0001 - Provides safe one-handed reflow and removal of a wide variety of Quad FlatPacks (PQFPs). High thermal efficiency design targets controlled SensaTemp heat on all solder joints simultaneously without damage to the substrate or adjacent components.
5. TT-65 ThermoTweez Handpiece - P/N 7025-0001 - Tweezer type device provides safe one-handed reflow and removal of PLCCs and other components. High thermal capacity and targeted heat quickly removes SMDs without damage to pcb or adjacent components.
6. TJ-70 Mini ThermoJet Handpiece - P/N 7023-0002 - Precision focused hot air reflow handpiece provides safe, rapid installation of a wide variety of SMD components. SensaTemp control provides safe, "on demand" capability without constant running of the air pump.
7. DTP-80 Dual ThermoPik Handpiece - P/N 7029-0001 - Provides safe one-handed reflow and removal of a wide variety of Quad FlatPacks (PQFPs) in a matter of seconds and can even remove BGAs (Ball Grid Arrays). High thermal efficiency design targets controlled SensaTemp heat on all solder joints simultaneously without damage to the substrate or adjacent components.



Service

Please contact PACE or your local distributor for service and repair.

Warranty Information:

LIMITED WARRANTY

PACE warrants that this equipment will be free of defects in materials and workmanship for a period of one (1) year from the date of receipt by original purchaser.

This warranty does not cover repair or replacement required as a result of misuse, mishandling or improper storage. Failure to perform recommended routine maintenance, alterations or repairs made other than in accordance with PACE's directions, or removal or alteration of identification plates in any way will void this warranty. This warranty is available only to the original purchaser, but the exclusions and limitations therein apply to all persons and entities.

This warranty does not apply to consumable items, such as tips, filter elements, hoses, collection chambers etc., except that heaters are normally warranted for a period of six (6) months from the date of receipt by the original purchaser.

PACE MAKES NO OTHER WARRANTY, EXPRESSED OR IMPLIED, AND MAKES NO WARRANTY OF MERCHANTABILITY OR FITNESS FOR A PARTICULAR PURPOSE.

PACE will, at its option, repair or replace any defective equipment or parts at its facility or other location approved by PACE at no charge to the user, or provide parts without charge for installation by the user in the field at user's expense and risk. User will be responsible for all costs of shipping equipment to PACE or other warranty location for warranty service.

EXCEPT FOR THE REMEDY ABOVE DESCRIBED, UNLESS OTHERWISE REQUIRED BY APPLICABLE LAW, PACE WILL HAVE NO OTHER OBLIGATION WITH REGARD TO ANY BREACH OF WARRANTY OR OTHER CLAIM WITH RESPECT TO THE EQUIPMENT, OR LIABILITY FOR ANY DIRECT, INDIRECT, CONSEQUENTIAL, OR INCIDENTAL LOSS OR DAMAGE CAUSED BY OR OCCURRING IN CONNECTION WITH ANY OF THE EQUIPMENT.

Do NOT return defective equipment or parts to PACE without obtaining prior authorization.

Any warranty or other claim with respect to the equipment must be made in writing and delivered to PACE (or local authorized PACE Distributor outside the U.S.) within a reasonable time of the expiration date of this warranty. Sufficient evidence of purchase and date of receipt must also be included, otherwise user's rights under this warranty shall be deemed waived.