



Operation and Maintenance Manual for *IntelliHeat*™ Power Sources

P/N 5050-0556 REV. 03/06/2015
This manual applies to: Version 2.0

Model	Part Number
ST 30	7008-0290-01
ST 30E	7008-0290-02
ST 50	7008-0291-01
ST 50E	7008-0291-02
ST 65	7008-0292-01
ST 65E	7008-0292-02
ST 70	7008-0293-01
ST 70E	7008-0293-02
ST 75	7008-0294-01
ST 75E	7008-0294-02
ST 115	7008-0295-01
ST 115E	7008-0295-02





TITLE	PAGE
General Information	
Introduction	3
Specifications	3
Power Source Requirements	3
Shop Air Input Requirements	3
Temperature Specifications (All Models)	3
Vacuum and Air (ST 65, ST 75 & ST 115)	3
EOS/ESD Specifications (All Models)	3
Power Supply Features	4
Safety	
Safety Guidelines	7
System Set-Up	
Mounting Options (ST 30, ST 50, ST 65, & ST 70)	7
Tip & Tool Stand Mounting Option (SX 90, PS 90, & TJ 85)	7
Handpiece Connection (All Models)	8
Air Supply Connection (ST 65 Only)	8
Handpiece Vacuum/Pressure (ST 65, ST 75, & ST 115)	9
System Power Up	9
Analog Temperature Controlled Power Supplies (ST 30, ST 65, & ST 75)	
Operation	10
Temperature / Dial Lock	10
Analog Control LED Operation	10
Digital Temperature Controlled Power Supplies (ST 50, & ST 115)	
Operation	11
Digital Control LED Operation	11
LED Display	12
Temperature Setback Mode	12
Activating Setback Mode	12
Exiting Temperature Setback	12
Auto Off Mode	12
Exiting Auto Off	12
THC Tip Calibration (ST 50 and ST 115)	13
Customizing Your System	13
Introduction	13
Entering Set-Up Mode	13
Password	14
Temperature Scale	14
Temperature Limits	14
Temperature Setback	14
Auto Off	15
THC Calibration Offset Mode	15
Exiting Set-Up Mode	15
Default Factory Settings	16
Power Module Controlled Power Supply (ST 70)	
Operation	16
Auto- Setback and Auto Off Features	16
Power Module Controlled LED Operation	17
Replacement Power Modules	17
System Calibration	18
Corrective Maintenance	19
Spare Parts	20
Service	20
PACE LIMITED WARRANTY STATEMENT	20



General Information

Introduction

Thank you for purchasing an *IntelliHeat™* system.. This manual will provide you with the information necessary to properly set up, operate, and maintain your system. Please read this manual thoroughly before using the system.

The systems featured in this guide are available in either 115 VAC or 230 VAC versions. All of these models incorporate Intelliheat™ technology. Intelliheat™ is the combination of THC (Tip Heater Cartridge) and SensaTemp handpieces into one system. The system recognizes either handpiece individually and automatically adjusts the menu driving controls for each handpiece. The 230 VAC version system bears the CE Conformity Marking, which assures the user that it conforms to EMC 89/336/EEC. All models featured in this manual are lead free compatible and comply with RoHS and WEEE directives.

Specifications

Power Source Requirements

Domestic Models		Export Models	
ST 30	Operates on 97-127 VAC, 50/60Hz, 80 Watts maximum at 115 VAC, 60Hz	ST 30E	Operates on 197-253 VAC 50/60Hz, 80 Watts maximum at 230 VAC, 50Hz
ST 50			
ST 65			
ST 70			
ST 75			
ST 115			

Shop Air Input Requirements (ST 65 Only)

Pressure- 5.48 Bar (80p.si.) recommended
Airflow- 45.3 SLPM (1.6SCFM) minimum

Temperature Specifications (All Models)

Tip Heater Cartridge Handpiece Tip Temperature Range: 205 to 455°C (400 to 850°F) nominal.
SensaTemp Handpieces Tip Temperature Range: 37 to 482°C (100 to 900°F) nominal.
Digital Readout Resolution: ±5° (°C or °F)
Tip Temperature Stability: ±1.1°C (2°F) at Idle from Set Tip Temperature.
Temperature Accuracy: Meets or exceeds ANSI JSTD 001

VACUUM AND AIR (ST 65 ST 75 & ST 115) Measurements at front panel AUTO SNAP-VAC and CONTROLLABLE PRESSURE Port.

Vacuum Rise Time: 150 ms average.
Vacuum: 20 in. Hg. (Nominal)
Pressure: (18 P.S.I.) (Nominal MAXIMUM setting)
Air Flow: 8 SLPM MAXIMUM

EOS/ESD Specifications (All Models)

Tip-To-Ground Resistance: Less than 2 ohms.
AC Leakage: Less than 2 Millivolts RMS from 50Hz to 100MHz.
Transient Level: Less than 500mV peak, out to 100MHz.

Power Supply Features

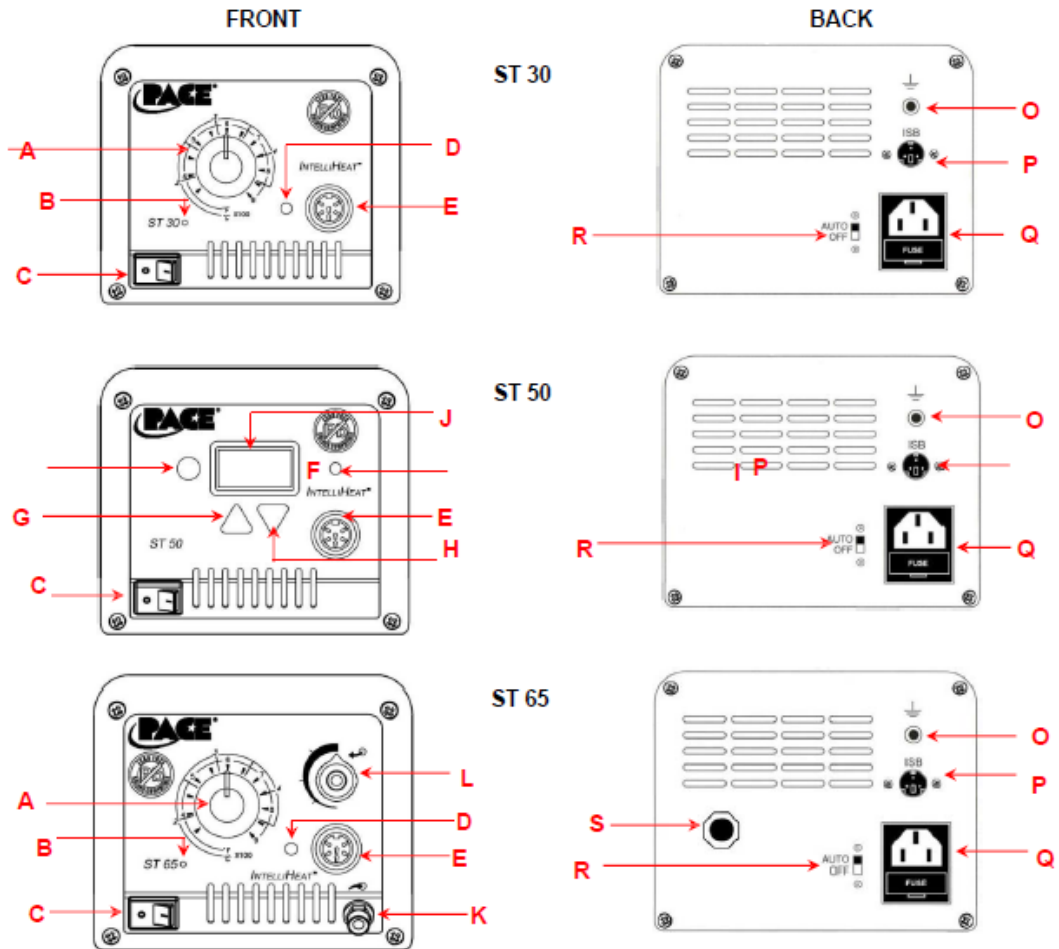

Soldering



Baskiville
ELECTRONIC INDUSTRY SPECIALISTS

Sole registered supplier of Pace products in New Zealand

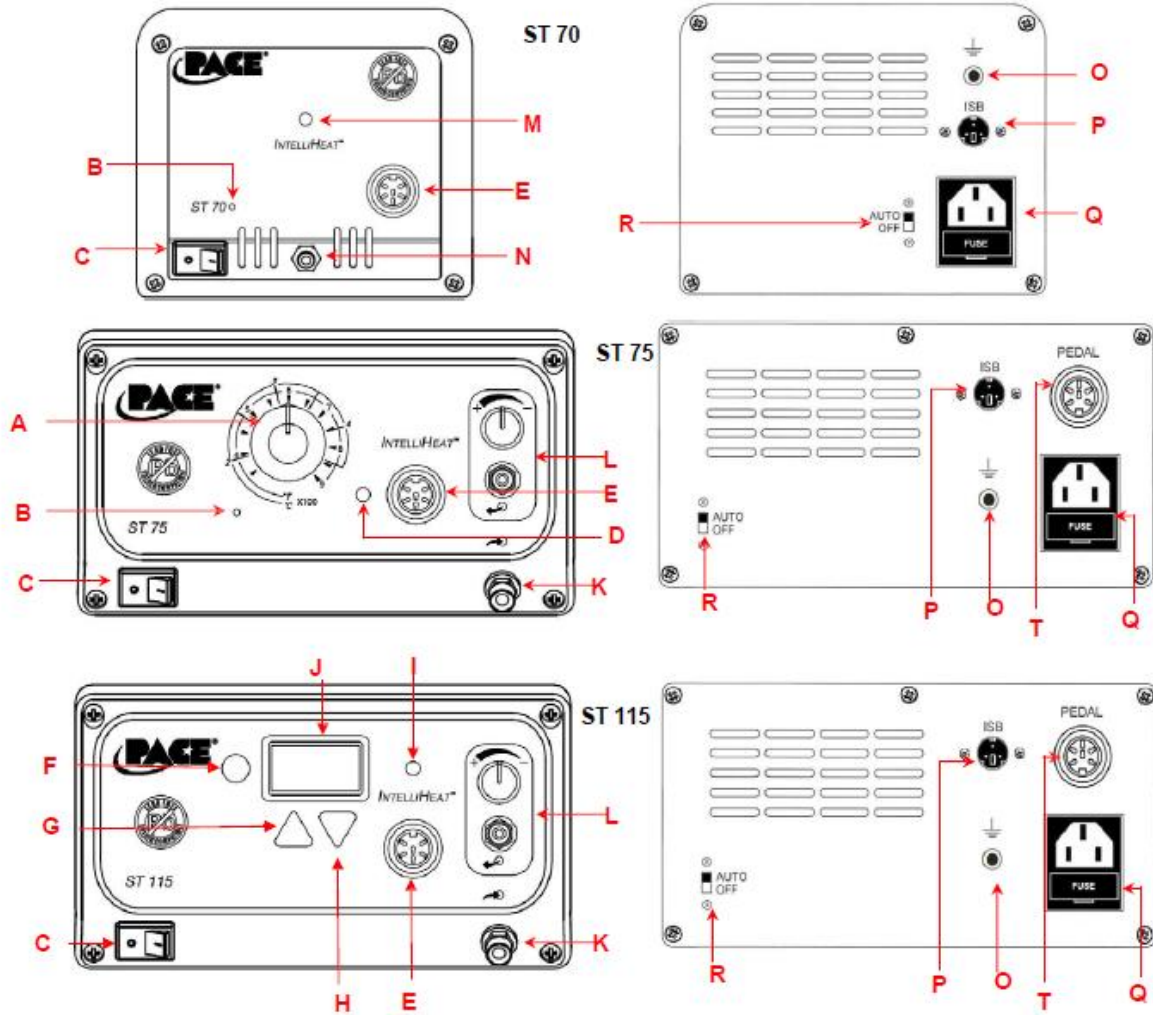



	Feature	Description
A	Analog control knob	Regulates tip temperature on ST 30, ST 65, & ST 75 power supplies.
B	THC fine control	For fine adjustment of true tip temperature (Tip heater Cartridge handpieces only).
C	Power switch	On /off control of power supply.
D	Analog control LED	Indicates status of power supply.
E	Power Receptacle	Front panel connection of handpiece.
F	Program button	For access and confirmation of program menu functions.
G	Up arrow button	Increase set temperature and scroll through program menu functions.
H	Down arrow button	Decrease set temperature and scroll through program menu functions.
I	Digital control LED	Indicates status of power supply.
J	Digital display	Displays temperature setting and menu functions.
K	Vacuum inlet	Vacuum connection for SX-90, TP-65, & TP-100 Handpieces.
L	Pressure control valve / port	Pressure / airflow connection and control for TJ-85 handpiece.
M	Power module LED	Indicates status of power supply.
N	Power module jack	Allows user to increase or decrease performance level using individual power modules.
O	Ground jack	For ground system to static safe work area.
P	ISB connection	Connection for Instant Set Back cubby.
Q	Power inlet with fuse	Connection for IEC power cord and fuse replacement.
R	Auto off switch	Activates auto off feature
S	Shop air connection	Connection for regulated air supply (ST 65 power supply only)
T	Foot pedal connection	Optional control for pressure / vacuum handpiece activation. (Required for TJ-85)



Safety Guidelines

The following are safety precautions that personnel must understand and follow when using or servicing this product.

1. **POTENTIAL SHOCK HAZARD** - Repair procedures on PACE products should be performed by Qualified Service Personnel only. Line voltage parts may be exposed when the equipment is disassembled. Service personnel must avoid contact with these parts when troubleshooting the product.
2. All handpiece heaters and installed tips are hot when the handpiece is powered on and for a period of time after power off. **DO NOT** touch either the heater or the tip. Severe burns may result.
3. PACE Tip & Tool Stands and handpiece cubbies are designed specifically for use with the associated handpiece and houses it in a manner that protects the user from accidental burns. Always store the handpiece in its holder. Be sure to place the handpiece in its holder after use and allow heater / tip to cool before storing.
4. Always use PACE systems in a well-ventilated area. A fume extraction system such as those available from PACE are highly recommended to help protect personnel from solder flux fumes.
5. Exercise proper precautions when using chemicals (e.g., solder paste). Refer to the Material Safety Data Sheet (MSDS) supplied with each chemical and adhere to all safety precautions recommended by the manufacturer.

System Set-Up

Set up the Intelliheat™ system using the following steps.

1. Store the shipping container in a convenient location. Reuse of these containers will prevent damage if you store or ship your system.
2. Place the Power Switch in the "OFF" or "0" position.



Mounting Options (ST 30, ST 50, ST 65, & ST 70)

The power supply can be placed directly on a workbench or it also can also be mounted under a workbench or shelf to conserve space (*optional mounting P/N 1321-0609-P1 bracket sold separately*). To mount the system in this way:

1. Mount the bracket in the desired location (fasteners not supplied).
2. Insert the 2 Mounting Screws (head first) into the power source mounting slots.
3. Place the washers over the screws.
4. Fit the power source between the bracket's support arms and place the screws into the slots on the support arms.
5. Place the nut on the screw and tighten by hand.
6. Angle the power source so the operator can see the front panel easily.
7. Tighten the nuts with a wrench or pliers.



Tip & Tool Stand Mounting Option (For SX 90, PS 90, and TJ 85)

The Tip & Tool Stand can be mounted to the power source. If the system will be placed on the workbench, this is recommended. If the power supply is to be mounted under the workbench or shelf, the Tip & Tool Stand should not be mounted to the power source.



- To attach the stand to the power source:
1. Insert the 2 large hex head Mounting Screws (head first) into the lower "T" slot on the side of the power source case as shown.
 2. Place the Tip & Tool Stand beside the power source. Insert ends of the 2 Mounting Screws into the 2 Tip & Tool Stand mounting holes as shown.
 3. Install a Thumb Nut onto the end of each Mounting Screw and tighten Thumb Nuts.
 4. Place the handpiece into its Tip & Tool Stand.

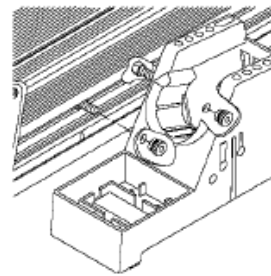

Handpiece Connection (All Models)

Connect the handpiece connector plug into the Power Receptacle in the following manner.

1. Align guide on connector with slot on power receptacle.
2. Insert connector into power receptacle.
3. Turn the connector housing clockwise to lock in place.

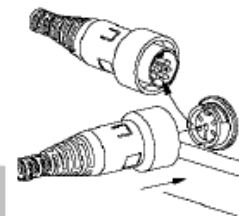

NOTE

IntelliHeat systems are designed for use with PACE handpieces with blue power connectors. Older "black" connector handpieces can be used by purchasing the optional adapter (P/N 6993-0278-P1).

Air Supply Connection (For ST 65 Only)

The ST 65 system utilizes an integral air venturi system to provide air pressure and vacuum for any connected PACE handpiece requiring air/vacuum. Your in-house air supply must be connected to the system power source.

IMPORTANT

The system must be connected to a clean, dry, and filtered, compressed air supply regulated to 5.48 Bar (80 P.S.I.).

1. Connect air supply to the ST 65's air inlet on the back of the system.
2. Install the Connector (with Small, Flexible Air Hose) onto the Air Hose Fitting (or metric adapter) finger tight. Using an appropriate wrench, tighten the Connector an additional 1/4 turn. **DO NOT** over tighten.
3. Connect the free end of a the air hose to your air supply using the appropriate fittings.

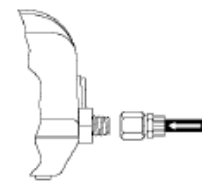

NOTE

The Air Hose Fitting on the rear of the ST 65 requires a 1/8-27 NPT threaded airline fitting (to be supplied by customer). **DO NOT** over tighten connections. Damage to the system could occur if excessive torque is applied to the Air Hose Fitting, Connector, or Metric adapter (G1/8 ISO thread, Part Number 1259-0081).



Handpiece Vacuum/Pressure (ST 65, ST 75, & ST 115)

To set up your handpiece air hose connection, perform the following steps:

1. Air Hose To Handpiece Connection
 - a) Attach one end of a 137cm (54 inch) length of air hose to the metal tube in the back of the handpiece.
 - b) Attach the air hose to the power cable using the supplied Hose clips. Space them evenly along the length of the power cable starting at a point 6 inches from the ends of the handpiece cable.
2. When using vacuum
 - a) Prepare a VisiFilter (if needed) in the following manner:
 1. Connect a 1-inch (2.5cm) length of clear pvc air hose to the FLOW OUT side of the VisiFilter.
 2. Insert the ribbed end of a male quick-fit connector (P/N 1259-0087) into the free end of the 1 inch (2.5cm) length of air hose connected to the FLOW OUT side of the VisiFilter.
 3. Connect the free end of the 137cm (54 inch) length of air hose to the FLOW IN side of the VisiFilter.
 4. Insert the end of the quick-fit connector (on VisiFilter FLOW OUT side) into the power source Vacuum Port.
3. When using air pressure:
 - a) connect one end of the 54" black air hose to the end of the handpiece
 - b) Insert the ribbed end of a male quick-fit connector (P/N 1259-0087) into the free end of this air hose .
 - c) Insert the smooth end of the quick-fit connector into the pressure port of the system and adjust pressure as required.

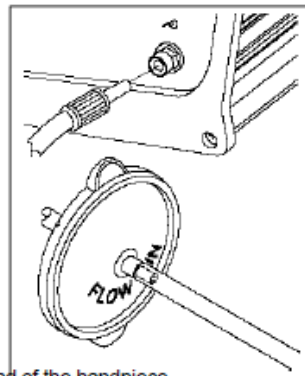

System Power Up

1. Insert the female end of the power cord into the AC Power Receptacle on the rear panel of the power source.
2. Plug the prong end (male end) of the power cord into an appropriate 3 wire grounded AC supply receptacle.

Dial Temperature Controlled Power Supplies ST-30, ST-65, and ST-75

Operation

Adjust the Temperature Control Knob to the desired temperature setting. Notice that the control panel has an outer graphic scale denoting temperature in °C (Celsius) and an inner graphic scale denoting temperature in °F (Fahrenheit). These numerical scales denote the set tip temperature times 100 (e.g., "3" on the outer scale is 3 x 100 or 300°C).

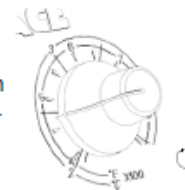

Temperature/Dial Lock

The Variable Temperature Control Knob can be locked in position to avoid accidental or unauthorized changes of the temperature setting.

1. Adjust the Temp. Control Knob to the desired temperature setting.
2. Using the Temp. Locking Key (hex key supplied with system), tighten the setscrew on the Temp. Locking Ring closest to the front panel.





Dial Control LED Operation

The colored LED on the power source front panel indicates Power Receptacle output status.

LED Full On Red – A fault has occurred. Check or replace handpiece tip.

LED Full On Green – Handpiece tip has reached set temperature.

LED Flashing Amber – Unit is in setback. Instant Set Back (ISB cubby) or the setback feature has been activated.

LED Full On Amber - Power is being delivered to the handpiece but set temperature has not been reached.

LED Off - No power is being delivered to the handpiece heater. Unit may be in auto off mode. If the LED never illuminates, check for a faulty handpiece (see Corrective Maintenance section).

Auto-Setback and Auto-Off Features

The ST 30 & 75 systems come standard with Auto-Setback and Auto-Off Features. These are pre-programmed for 30 minute Setback and 30 minute Auto Off, which can be turned off by the switch on the back of the unit. When Setback mode has been entered, the temperature will be set to 176C (350 F).



Digital Display Temperature Controlled Power Supplies (ST 50 & ST 115)

Operation

1. Ensure that the Set-Up procedure has been performed. Check for the following:
 - a) Handpiece connection to the power source.
 - b) Proper tip installed in handpiece.
 - c) Power cord connection between an appropriate AC supply and the power source.
2. Turn the Power Switch On ("I").
3. Press the Scroll Up (▲) Key. The Set Temperature is now displayed, immediately perform step 4. If a Password has been previously programmed into the system, "EPO" will be appear on the LED Display at this point. When this message appears, the operator must enter the correct Password before adjusting the temperature.
4. Adjust the temperature by pressing and holding Scroll Up (▲) Key or Scroll Down (▼) key. Observe the display as the Set Temperature increases first in increments of 5° and then in increments of 10°. When the desired temperature is reached, release the key.

NOTE: The Set Temperature can only be adjusted within the defined temperature limits. If the upper limit has been reached, the display will read "HiL", if the Lo limit is reached; the display will read "OFF". Temperature limits can be adjusted in the Set-Up menu

5. An offset may be entered if using massive ST tips. To enter an offset, simply press the program key for 3 seconds while the system is in normal operation mode and enter the offset using the keypad. The display will return to normal display mode in 5-7 seconds.

If a THC iron is being used in Offset mode 2 with the reset capability turned on, and the LED is Amber (tip has been removed), then holding the program key for 3 seconds will reset the LED back to green.

Digital Control LED Operation

The colored LED on the power source front panel indicates calibration status.

LED Full On Red – A fault has occurred. Check handpiece and/or tip heater cartridge. Check handpiece connection to front panel.

LED Full On Green – Calibration of THC handpiece is complete or SensaTemp handpiece is connected

LED Full On Amber – Calibration has not been cleared but tip has been removed (Offset Control 2)

LED Blinks Amber – Calibration has not been completed or has been cleared (THC irons)

LED Off - Unit is in setback or Instant Set Back (ISB cubby) is activated.

LED Display, Normal Operation

The LED Display provides a 3-digit display of temperature information. The LED Display will show:

1. A display of "888" on initial power up to ensure that all LEDs on the display are working.
2. A display of the software version of the installed microprocessor (e.g., "1-9") for 2 seconds on initial power up after the "888" is displayed.
3. Actual tip temperature of the connected handpiece during normal operation.



4. The tip temperature displayed will flash when the system is in Temperature Setback.
5. The displayed temperature will decrease and stabilize at 177°C (350°F) when the system is in Temperature Setback.
6. "OFF" with stable display when the Set Tip Temperature has been set to Off (below minimum set tip temperature).
7. "OFF" with flashing display when the unit has entered Auto Off. Refer to the "Set-Up Mode" portion of this manual.
8. Error messages ("CHP", "SSE" or "OCE") if a system fault is detected. Refer to the "Corrective Maintenance" portion of this manual.

LED Display, Temperature Adjust Mode

The LED Display will show the following when adjusting the desired Set Tip Temperature.

1. The Set Tip Temperature.
2. "HiL" (High Temperature Limit) when adjusting the set tip temperature and the maximum allowable temperature is exceeded. Refer to the "Set-Up Mode" portion of this manual.
3. "OFF" (Low Temperature Limit) when adjusting the set tip temperature and the minimum allowable temperature is exceeded. Refer to the "Set-Up Mode" portion of this manual.
4. "EP" will be displayed if a Set Tip Temperature adjustment is attempted and a Password has been stored in system memory. As the Password is entered, the zero will increase by one as each key entry is made.
5. "no" will be displayed if the entered password does not match the stored Password.

Temperature Setback Mode

To preserve tip life and save energy, the ST 50 and ST 115 systems can be programmed to automatically set back its Tip Temperature to 177°C (350°F) after a selected period of handpiece inactivity (adjustable 10-90 minutes in Set-Up Mode). As received from the factory, this feature is enabled. There are 2 ways to exit Temperature Setback Mode:

1. Press and release Scroll up Key (▲).
2. Cycle the Power Switch.

Set Tip Temperature and Tip Offset values will be simultaneously restored. For optimum performance, do not attempt to use the attached handpiece until the Set Tip Temperature is achieved.

Auto Off Mode

When enabled, the Auto Off safety system of the ST 50 and ST 115 turns off the power to the handpiece 10-90 minutes after entering Temperature Setback. When the system has entered Temperature Setback, an Auto Off timer within the system circuitry will start running.



1. If any key is pressed during the selected time out period, the Auto Off and Setback timers are reset. The system will return to normal operation.
2. At the end of the time out period, the system will enter Auto Off. Power is turned off to the heater and the LED Display will show a flashing "OFF".

Exiting Auto Off: Auto Off can be exited; returning to normal operation by:

1. Pressing and releasing a Key (either of the 3 keys), or
2. By turning the Power Switch OFF ("0") and then back ON ("1").







THC Tip Calibration (ST 50 and ST 115)

To enter Calibration mode: Press and hold the Program Key () and the Scroll up Key () while turning on the Power Switch ("I" position). Release keys when the software version appears. Follow the procedure below.

Calibration Instructions

The steps for the procedure are:

1. Turn on the system.
2. Clear any offset from the system by disconnecting the handpiece from the system. Re-connect the handpiece and proceed to step 2.
3. LED should go to amber. Set to 700°F to (370°C).
4. Measure the actual temperature of the tip from your temperature verification device. Note results.
5. Turn off the system.
6. Enter Calibration mode: Press and hold the Program Key () and the Scroll up Key () while turning on the Power Switch ("I") position. Release both keys when the software version appears.
7. The display will now read "tIP". Press the Scroll UP Key () or DOWN Key () to enter the measured temperature from step 4. For example, your temperature verification device reads 695 °F. Scroll through until the display reads 695.
8. Press the Program Key () to save calibration. Upon exiting, LED will illuminate green and the display will return to normal operation mode.
9. See calibration display options in the THC Calibration Offset Mode Select section of the manual

Customizing Your System

Introduction

The menu driven LED Display of the ST 50 and ST 115 systems allows you to easily customize your system. In Set-Up Mode, you can:

- Enter, remove or change a Password.
- Set the Default Temperature scale to °F or °C.
- Change the Upper and Lower Temperature limits.
- Enable or disable the Temperature Setback feature and adjust the time-out period (if enabled).
- Enable or disable the Auto Off feature and adjust the time-out period (if enabled).
- Change the Default Calibration Offset Option.

Entering the Set-Up Menu

The following instructions should be performed to familiarize the operator with the system.

1. Place Power Switch in the "OFF" ("0") position.
2. Press and hold the Program Key () while turning on the Power Switch ("I" position).

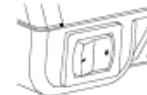



Password

3. The LED Display will display the version of the microprocessor and change to read "P--" or "EP".
 - a) If the display reads "EP", a Password has been stored in system memory. The password must be entered to access into the menu. If the wrong password is entered, "no" will appear on the display and the system will return to normal operation. If this occurs, repeat steps 1 & 2 and enter the correct Password.
 - b) The LED Display reads "P--". Choose one of the following options:
 - i. Press the Program Key () to keep the currently stored Password (including no Password).
 - ii. To enter a password, select a 3 digit number as the password using the keypad. (1 to 999). Make a note of the entered Password.

Temperature Scale

4. The LED Display now shows the stored default Temperature Scale (°C or °F temperature shown on LED Display). Choose one of the following:
 - a) Press the Program Key () to keep the stored default Temperature Scale.
 - b) Use the keypad to change the default Temperature Scale.
 - c) Press and release the Program Key to proceed to the next step



Temperature Limits

5. The LED Display now shows the stored default High ("Hi") Temperature Limit with the display alternating to show "Hi" and the stored limit. Choose one of the following:



- a) Press and release the Program Key () to keep the stored High Temperature Limit.
 - b) Adjust the stored High Temperature Limit using the keypad
 - c) Press and release the Program Key to proceed to the next step.

6. The LED Display now shows the stored default Low ("Lo") Temperature Limit with the display alternating to show "Lo" and the stored limit. Choose one of the following:



- a) Press and release the Program Key () to keep the stored Low Temperature Limit.
 - b) Adjust the stored Lo Temperature Limit (up to 482°C, 900°F) using the keypad.
 - c) Press and release the Program Key to proceed to the next step.

Temperature Setback

7. The LED Display now shows the stored Temperature Setback time as "S-X" (x=0 thru 9). Time is shown as tens of minutes (e.g., "S-3" equals 30 minutes). A display of "S-0" indicates that Setback is disabled. Choose one of the following:

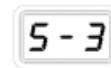

- a) Press and release the Program Key () to keep the currently stored Temperature Setback time.
 - b) Adjust the stored Temperature Setback value using keypad.
 - c) Press and release the Program Key to proceed to the next step.





Auto Off

8. The LED Display now shows the stored Auto Off time as "AOx" (x=0 thru 9). Time is shown as tens of minutes (e.g., "AO8" equals 80 minutes). A display of "AO0" indicates that Auto Off is disabled. Choose one of the following:
- Press and release the Program Key () to keep the currently stored Auto Off time.
 - Adjust the Auto Off value using the keypad.
 - Press and release the Program Key to proceed to the next step.



THC Calibration Offset Mode Select

9. The LED Display now shows the Calibration Offset Options as "OCx" (x=1 thru 3).
- Change the Offset Option by pressing Scroll Up (▲) Key or Scroll Down (▼) key.
 - Choose one of the following options:
 - "OC1" (Offset Control 1) Offset will clear to zero if either the handpiece or the tip is removed from the system. LED will change from Green to BLINKING Amber in either case.
 - This option could be selected when a variety of different tips are being used and the system should recalibrated after every tip change
 - This option is suitable if replacing the tip or the handpiece would always require the system to be recalibrated
 - "OC2" (Offset Control 2) Offset will clear to zero if the handpiece is removed from the system, but removing the tip will maintain the offset. LED will change from Green to BLINKING Amber if the handpiece is removed, and will change to SOLID Amber if the tip is removed.
 - This option is desirable when using tips of similar geometry where it is not necessary to formally recalibrate after a tip change.
 - This option would be desirable in situations where supervisors would want to be able to easily determine if the tip has been removed for any reason
 - "OC3" (Offset Control 3) Offset will clear to zero if the handpiece is removed from the system, but removing the tip will keep the offset. The LED will remain Green if the system has an offset. In this mode, the LED will change from Green to BLINKING Amber only if the handpiece is removed.
 - This option could be selected in applications when a the tip is rarely replaced or when the same style tip is used throughout the application
 - This option is suitable if only replacing the handpiece would require the system to be recalibrated
 - Press and release the Program Key () to proceed to the next step.
10. If you selected "OC2" (Offset Control 2), then you are greeted with one additional option L-0 and L-1, which implies that the reset to the LED is either ON (1) or OFF (0)
- If you select L-0, (Off), the LED will not reset back to Green without a full calibration.
 - If you select L-1, (On), then
 - If the tip is removed, the LED goes to SOLID amber, and the calibration is not lost. If you hold the program key  for 5 seconds, the LED goes back to Green, and you never lost the calibration.



- b) If the hand piece is removed, the LED goes to a blinking amber, and the calibration is lost, then the unit will need to be calibrated again (Kindly, refer to THC Tip calibration on page 13)

Exiting Set-Up Mode

11. The LED Display now reads "End". The Set-Up Mode procedure is now complete. Choose one of the following steps:

- Press and release the Scroll Up (▲) Key to exit Set-Up Mode and return to normal operation.
- Press and release the Scroll Down (▼) Key to return to the start of the Set-Up Mode procedure. Go back to step 4.

End

Default Factory Settings

The ST 50 and ST 115 systems come equipped with a number of features, which may be adjusted by the user. Listed below are the features and default settings of each. To change and/or learn about any of these features, refer to the applicable part of the "Customizing Your System" section of this manual.

Feature	Factory Setting
Password	None Entered
Default Temperature Scale (°C/°F)	°F for 115 VAC Systems °C for 230 VAC Systems
"HI" (Upper) Temperature Limit	427 °C (800 °F)
"LO" (Lower) Temperature Limit	260 °C (500 °F)
Set Temperature	371 °C (700 °F)
Tip Offset Constant	"0"
Temperature Setback	Enabled, 30 minutes
Auto Off	Enabled, 60 minutes
Calibration Offset	"OC3"

Power Module Controlled Power Supply

(ST-70)

Operation

The ST 70 requires the use of a Power Module. The Power Module selects the desired performance level for operation. The ST 70 comes standard with three Power Modules, Performance Levels 6.5, 7, & 7.5. Additional Power Modules are available in heat levels of 5, 5.5, 6, 8, and 8.5. A heat level of 5 corresponds to a nominal temperature of 500 °F; a heat level of 6.5 corresponds to a temperature of 650 °F, etc. Actual measured temperatures on the surface of the tip may vary due to tip geometry.

If the power is turned on while a Power Module is not installed, or if the Power Module is removed during operation, the system will turn itself off and the LED indicator light on the front panel will turn red. To operate the unit, please make sure the set-up procedure has been followed, then follow the procedure below.

- Install the desired tip heater cartridge or tip.
- Install the desired Power Module into the Power Port on the front of the unit.
- The LED indicator will turn amber while the tip is heating to the desired performance level.
- Once the tip has reached the desired heat level, the LED indicator will turn green and the system is ready to use.



Auto-Setback and Auto-Off Features

The ST 70 system comes standard with Auto-Setback and Auto-Off Features. These are pre-programmed for 30 minute Setback and 30 minute Auto Off, which can be turned off by the switch on the back of the unit. When Setback mode has been entered, the performance level will be adjusted to 3.5.

Power Module Controlled LED Operation

The colored LED on the power source front panel indicates Power Receptacle output status.

LED Amber to Green - This condition is evident when the system is first powered up (handpiece heater cold).

LED Green - Handpiece tip has reached set temperature.

LED Red - Indicates an open sensor. Handpiece, Tip Heater Cartridge or power module has been removed.

LED Off - System is in auto-off mode or no power is being delivered to the handpiece heater. If the LED never illuminates, check for a faulty handpiece or tip heater cartridge.

LED in Set back - The LED will be Amber or Green depending on the color when it entered Setback, or Auto Off.

Replacement Power Modules

PACE Power Modules			
Part Number	Color	Series	Nominal Temp
1207-0446-01-P1	Green	5	260 °C (500 °F)
1207-0446-02-P1	Turquoise	5.5	288 °C (550 °F)
1207-0446-03-P1	Orange	6	316 °C (600 °F)
1207-0446-04-P1	Gold	6.5	343 °C (650 °F)
1207-0446-05-P1	Red	7	371 °C (700 °F)
1207-0446-06-P1	Violet	7.5	399 °C (750 °F)
1207-0446-07-P1	Black	8	427 °C (800 °F)
1207-0446-08-P1	Silver	8.5	454 °C (850 °F)
*Note: Each ST-70 system includes (1) each 6.5, 7.0, & 7.5 power modules			



System Calibration

All systems are tested for temperature accuracy at the factory and can be checked for calibration according to requirements. No internal adjustments can be made to the power supply. In general, SensaTemp based technology handpieces (PS-90, SX-90, TT-65, TJ-85) do not need to be calibrated as they feature a laser trimmed, platinum RTD sensor.

1. Install a tip with an embedded thermocouple into the handpiece connected to the system. Tips with K type thermocouples welded to them are available from PACE.
2. Connect the thermocouple assembly to a compatible k-type thermo couple meter, PACE's Tip Temperature Monitor (P/N 8001-0087-P1) or PACE's PM 200 (P/N 8007-0464-P1).
3. Turn on system and allow the tip to stabilize at the set temperature.
4. Record measured temperature on monitor.

To Adjust Dial Control Systems (ST 30, ST 65, and ST 75)

1. When using a SensaTemp based handpiece, if the temperature displayed varies from the dial setting, the dial can be adjusted to precisely match.
 - a. carefully lock the Variable Temperature Control in position by tightening the inner set screw (closest to front panel).
 - b. Loosen the outer setscrew on the Variable Temperature Control knob (furthest from front panel) using the Temp. Locking Key (hex key) supplied with the system.
 - c. Position the knob with the pointer aligned to match the temperature indicated on the temperature meter.
 - d. Secure the knob in position by tightening the outer setscrew.
 - e. Loosen the inner setscrew to unlock the Variable Temperature control if adjustment of operating tip temperature is desired.
2. Tip heater Cartridge Adjustment. This feature will only work with TD-100, MT-100, and TP-100 handpieces. The PACE ST 30, ST 65, and ST 75 feature a temperature adjustment. This adjustment is located within the small hole on the front panel and may be accessed using a small flat blade screwdriver. Adjust adjustment screw until measured tip temp matches dial selected temperature. With most tip geometries this feature will not need adjustment. Extended or fine tips may require adjustment. This adjustment will allow for temperature adjustments of $\pm 30^{\circ}\text{C}$ (50°F).

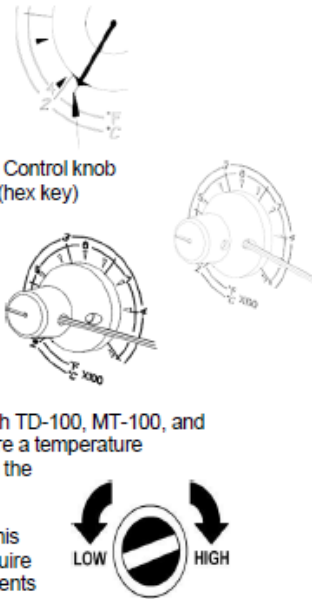

To Adjust Digital Temperature Control Systems (ST 50 & ST 115).

1. Turn off power source and turn it back on while holding down the program (round) key and the up key.
2. The system will prompt you to enter the measured temperature using the keypad.
3. Press the program key and the system will restart.
4. To clear the calibration, remove the handpiece while the power source is ON.



To Adjust Power Module Control System (ST 70)

- 1 SensaTemp Handpieces – No adjustment possible, select a performance level that results in the desired temperature.
- 2 Tip heater Cartridge Handpieces – Use the adjustment screw as described under "To adjust Dial Temperature Control Systems/Tip heater Cartridge Adjustment."

Corrective Maintenance

Digital Display Message Codes

Listed below are message codes, which, may be shown on the LED Display if a mistake were to be made by the operator (e.g., wrong Password entry) or if the system has malfunctioned.

LED Display Message	Description
	The incorrect password has been entered. The displayed message will time out after 6 seconds and revert to normal operation. Enter the correct password.
	"Check Handpiece" No handpiece is connected to the power receptacle. Connect handpiece
	The handpiece heater assembly sensor is open. Refer to the appropriate handpiece manual (ST Products Only).
	"Shorted Sensor Error" The handpiece heater assembly sensor is shorted. Refer to the appropriate handpiece manual.
	"Over Circuit Error" The handpiece heater assembly may be defective. Refer to the appropriate handpiece manual Contact PACE or your authorized local representative for assistance.

Power Source

Most malfunctions are simple and easy to correct.

Symptom	Probable Cause	Solution
No power to system	Blown Fuse	Check handpiece using Heater Assembly Checkout Procedures in the appropriate handpiece manual. Replace the fuse (located in the AC Receptacle Fuse Holder) with one of the same rated value (see Table 4, Spare Parts)
Handpiece will not heat	Defective Heater	Refer to the appropriate handpiece manual
	Power Source Malfunction	Contact PACE



Spare Parts

Item #	Description	PACE Part Number
1	Fuse, 1.0 Amp Time Lag	1159-0246-P5
	Fuse, 0.5 Amp Time Lag (Export Models)	1159-0213-P5
2	Silicone tubing (For SX-90 & TJ-85 Handpiece)	1342-0015-08
3	Quick disconnect (male fitting)	1259-0087-P1
4	Venturi solenoid kit (ST 65 Only)	6993-0201
5	VisiFilter Sealed)	1309-0020-P1
6	VisiFilter Replaceable	1309-0028-P1
7	Replaceable VisiFilter Elements - Package of 10	1309-0027-P10
8	Replaceable VisiFilter Elements - Package of 50	1309-0027-P50

Service

Please contact PACE or your local distributor for service and repair.

PACE LIMITED WARRANTY STATEMENT

Limited Warranty

Seller warrants to the first user that products manufactured by it and supplied hereunder are free of defects in materials and workmanship for a period of one (1) from the date of receipt by such user. This Warranty as applied to blowers and motor pumps is limited to a period of six (6) months. Other brand equipment supplied but not manufactured by PACE are covered under their respective manufacturer's warranty in lieu of this Warranty.

This warranty does not cover wear and tear under normal use, repair or replacement required as a result of misuse, improper application, mishandling or improper storage. Consumable items such as tips, heaters, filters, etc. which wear out under normal use are excluded. Failure to perform recommended routine maintenance, alterations or repairs made other than in accordance with Seller's directions, or removal or alteration of identification markings in any way will void this warranty. This warranty is available only to the first user, but the exclusions and limitations herein apply to all persons and entities. SELLER MAKES NO OTHER WARRANTY, EXPRESS OR IMPLIED, AND MAKES NO WARRANTY OF MERCHANTABILITY OR FITNESS FOR A PARTICULAR PURPOSE.

Seller will, at its option, repair or replace any defective products at its facility or other location approved by it at no charge to user, or provide parts without charge for installation by the user in the field at user's expense and risk. User will be responsible for all costs of shipping equipment to Seller or other location for warranty service.

EXCEPT FOR THE REMEDY ABOVE DESCRIBED, UNLESS OTHERWISE REQUIRED BY APPLICABLE LAW, SELLER WILL HAVE NO OTHER OBLIGATION WITH REGARD TO ANY BREACH OF WARRANTY OR OTHER CLAIM WITH RESPECT TO THE PRODUCTS, OR LIABILITY FOR ANY DIRECT, INDIRECT, CONSEQUENTIAL, OR INCIDENTAL LOSS OR DAMAGE CAUSED BY OR OCCURRING IN CONNECTION WITH ANY OF THE PRODUCTS.

Warranty service may be obtained by contacting the appropriate PACE Company or local Authorized PACE distributor as set forth below to determine if return of any item is required, or if repairs can be made by the user in the field. Any warranty or other claim with respect to the products must be made with sufficient evidence of purchase and date of receipt, otherwise user's rights under this warranty shall be deemed waived.



www.paceworldwide.com

www.facebook.com/paceworldwide

For PACE USA Customers:

PACE Worldwide
255 Air Tool Drive
Southern Pines, NC 28387
phone 1.877.882.PACE
fax 910.695.1594

For PACE EUROPE Customers:

PACE Europe Limited
11 Holdom Avenue
Bletchley, Milton Keynes,
Buckinghamshire, MK1 1QU (UK)
phone +44 1908 277666
fax +44 1908 277777

All other Customers:

Local Authorized PACE Distributor